

The background of the entire page is a photograph of a roof with dark grey, interlocking tiles. The tiles are arranged in a pattern that recedes into the distance, creating a sense of depth. The sky is a clear, deep blue.

Performance Over Everything

ROOF FRAMING INFORMATION

BATTEN INSTALLATION

TILE INSTALLATION

ACCESSORY INSTALLATION

ESTIMATING DATA

GENERAL INFORMATION

ROOF FRAMING INFORMATION

It is the responsibility of roofers, building contractors and architects to ensure that local standards, by-laws and regulations are satisfied. It is essential that all installation is carried out in the manner prescribed in the Gerard Tile Installation Manual.

Gerard Tile Roofing can be installed on any pitch from 15°, or 12° with a suitable underlay, to vertical mansards. Cost savings may be obtained if rafter lengths are designed to accommodate an exact number of tile courses. Where this is not possible, cutting of the top tile course will be necessary. Rafters or roof trusses can be set at various centres depending on the type of

construction and local regulations. In most situations the following batten sizes are recommended.

Recommended Rafter or Truss Centres	Batten Size
up to 900mm	50 x 40mm
1200mm	50 x 50mm
1500mm	50 x 65mm (on edge)
1800mm	50 x 75mm (on edge)

1. ROOF FRAMING INSTALLATION

1.1 RIDGE

Should be installed 50mm plus batten height above rafters and formed from 25mm thick timber (Fig 1.1.1, 1.1.2, 1.1.3).

FIG 1.1.1

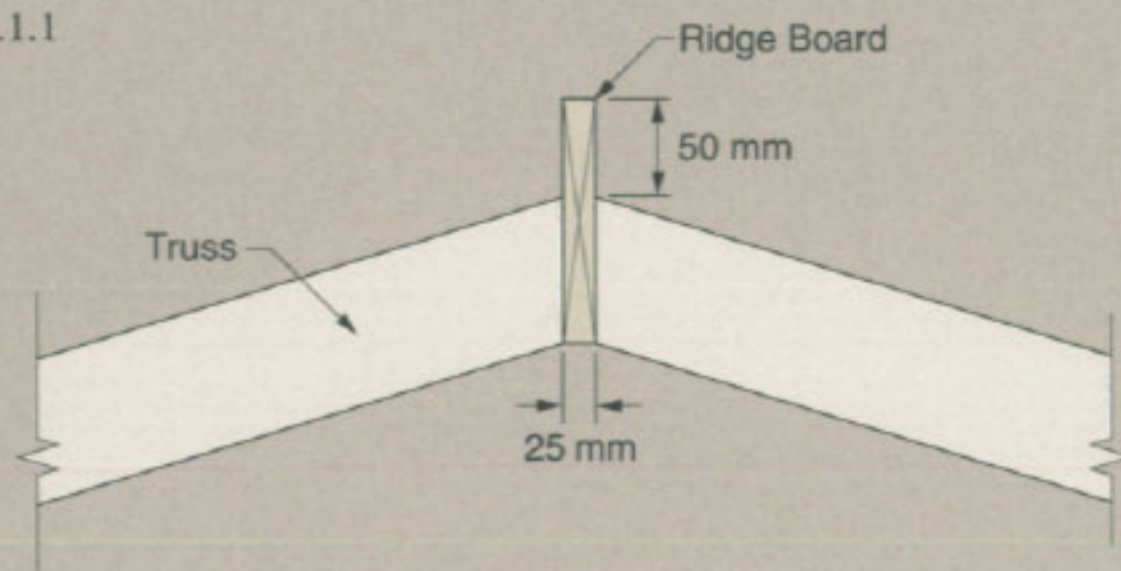

FIG 1.1.2

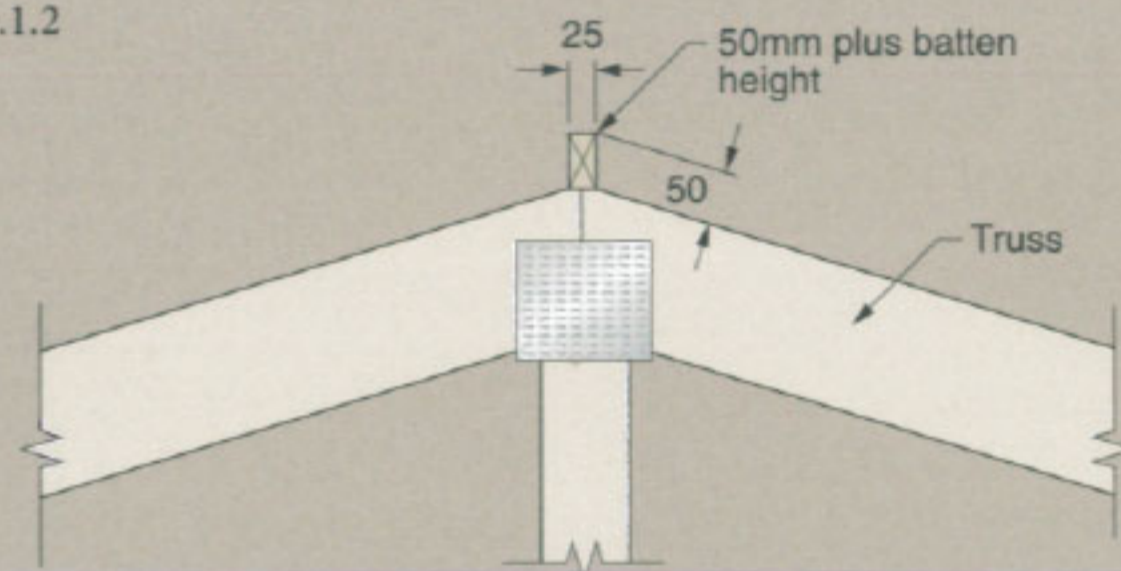
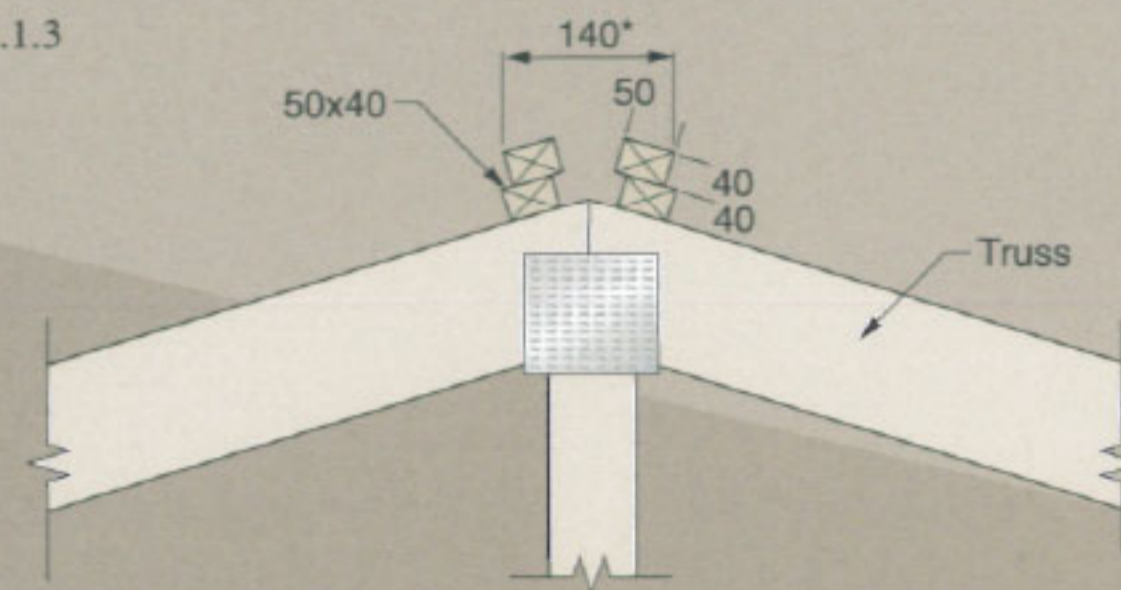

FIG 1.1.3



* dimension will vary depending on roof pitch

1.2 BARGE BOARDS

Install the barge board 40mm above the rafter where barge accessory is used (Fig 1.2.1). Tolerance ranges from a minimum of 25mm to a maximum of 60mm above rafter. Note that the edge of the tile is bent up under the barge cover to ensure complete weather security.

FIG 1.2.1

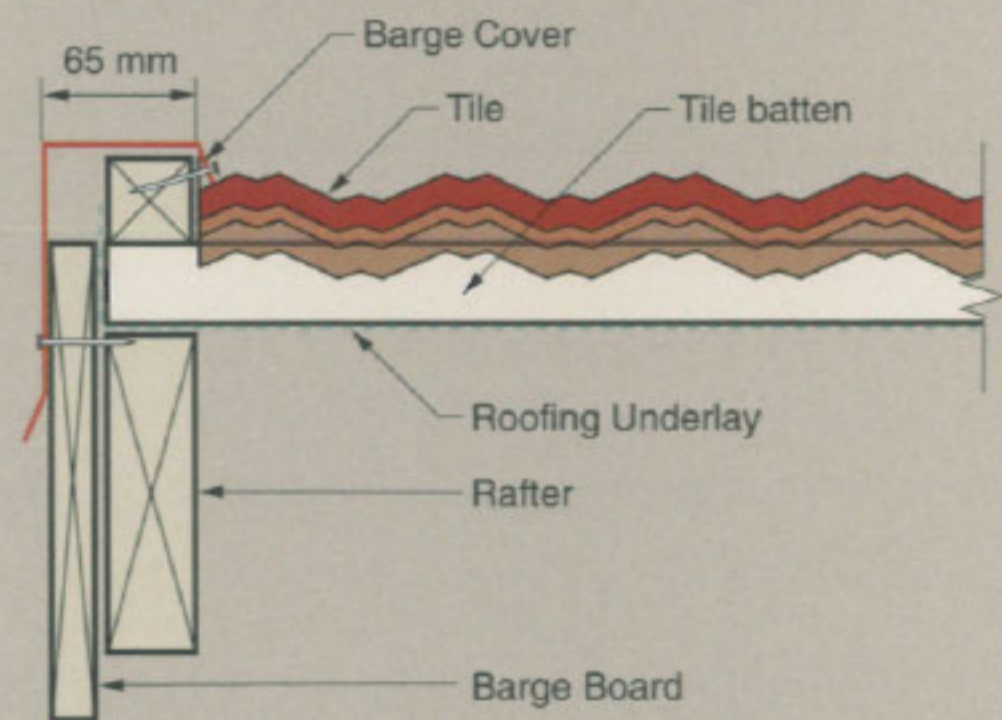

1.3 HIP

A hip with battens installed for Barrel is shown (Fig 1.3.1).

If a hip board is present, battens may be installed alongside the hip board ensuring that the batten edges are no more than 140mm apart.

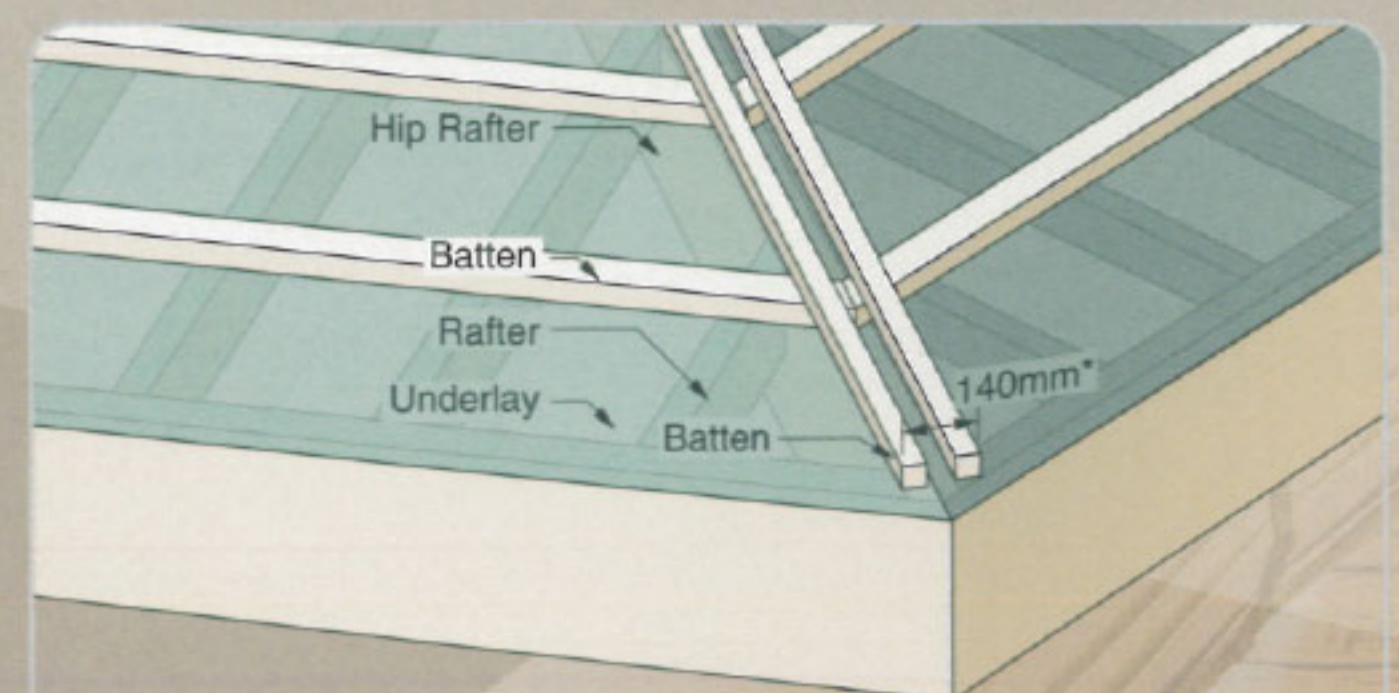

FIG 1.3.1

* May vary depending on pitch of roof

1. ROOF FRAMING INSTALLATION

1.4 FASCIA

At the eaves install the fascia up to the batten height above rafters (Fig 1.4.1).

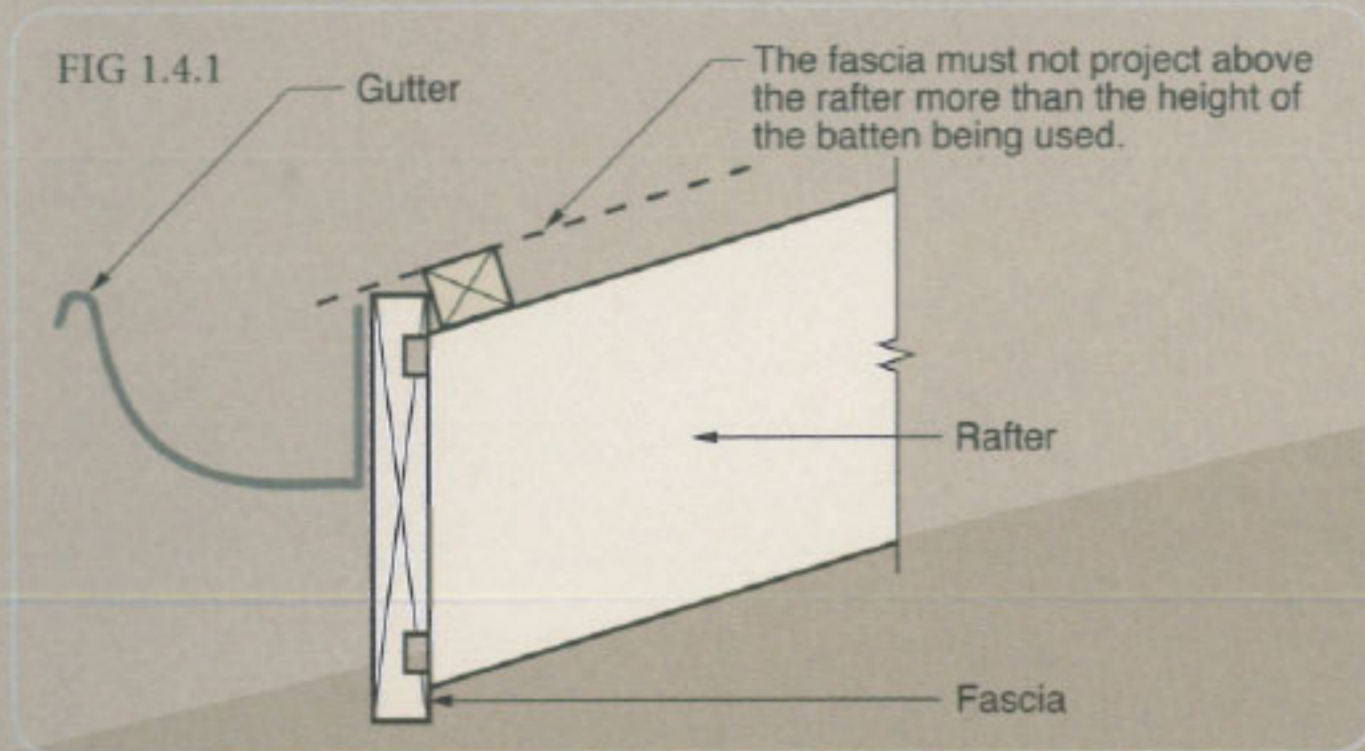

Where a rainwater collection system (eaves guttering) is not used but the tile overhangs the fascia, secure a 50 x 25mm dressed batten to the front edge of the fascia before the tiles are laid. The width of the batten should be of a width to fit the overhang of the tiles (Fig 1.4.2).

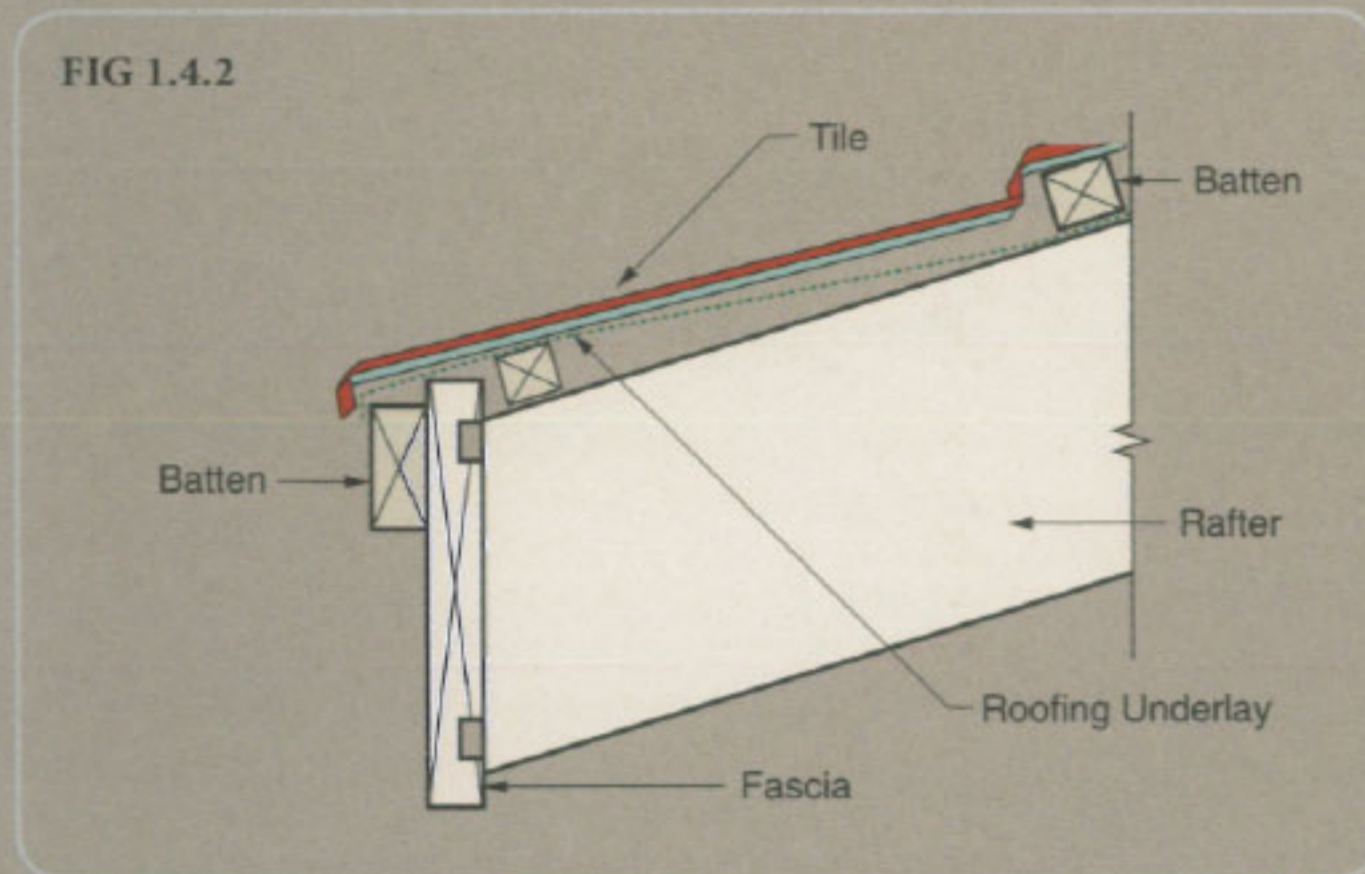

1.5 VALLEYS

The following details suggest two ways in which the valley lining may be fitted. Local practice, building regulations and site conditions will dictate the final method used.

150mm x 25mm Valley boards are cut between the trusses and nailed flush with the top of the rafters

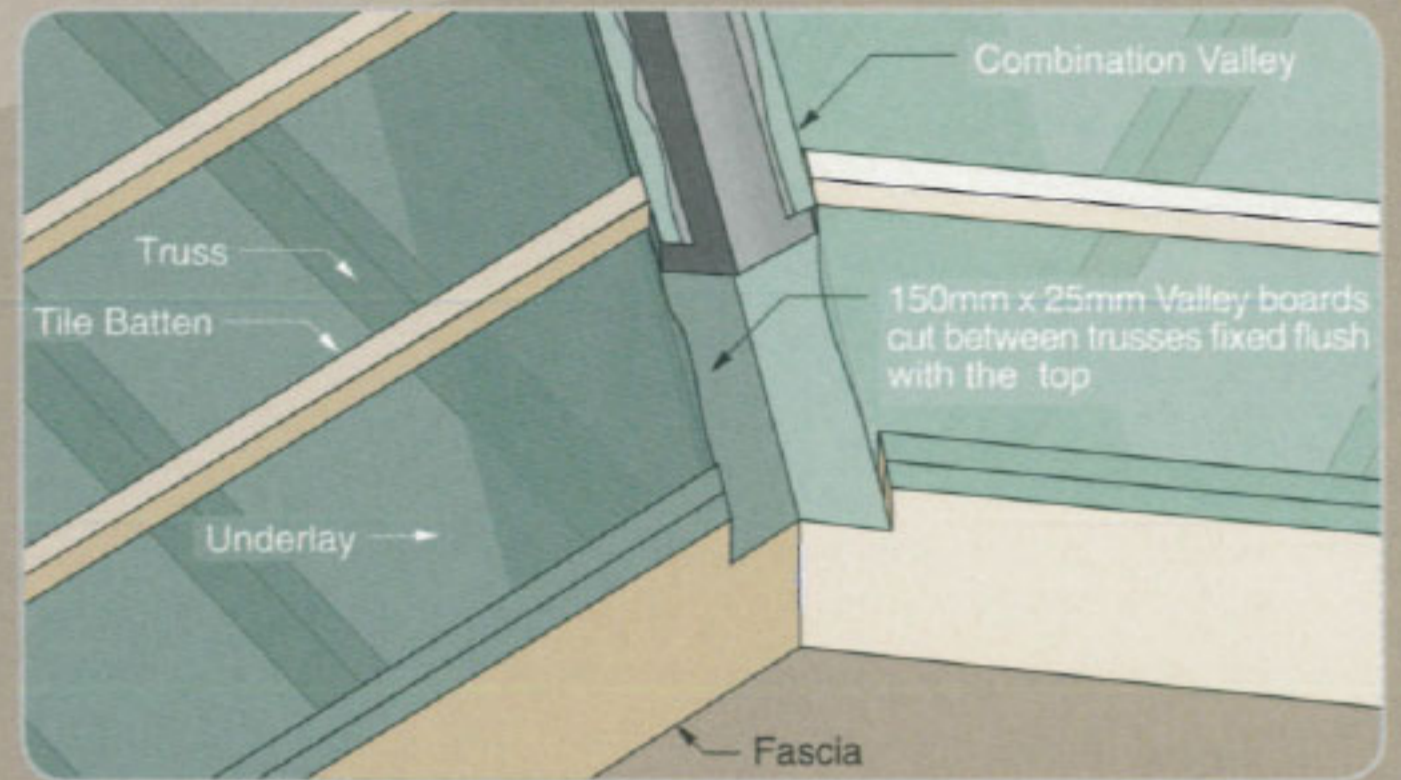

FIG 1.5.1

Prefabricated Trusses

150mm x 25mm cut between trusses fixed flush with the top.

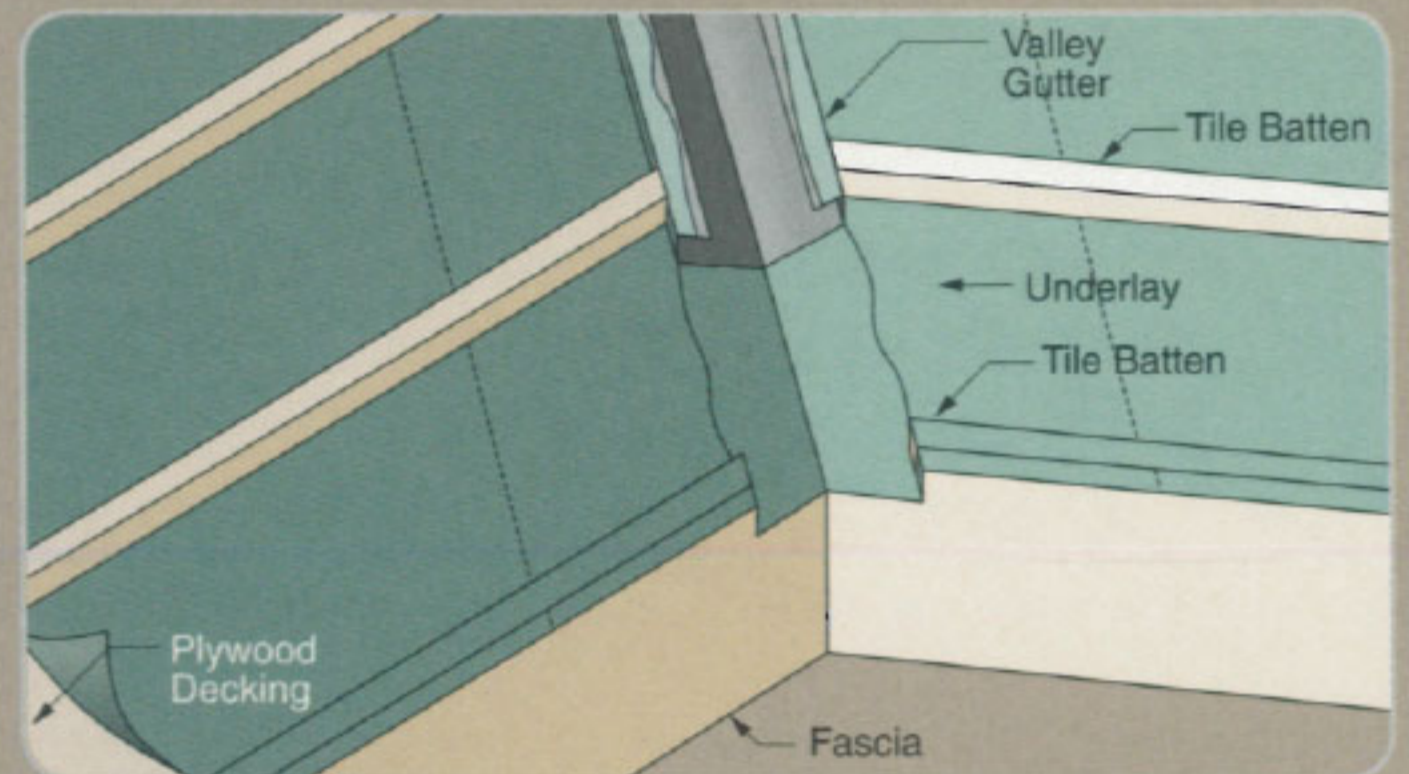
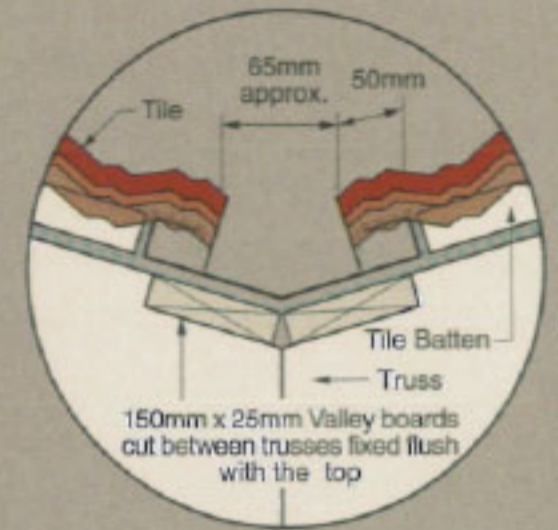
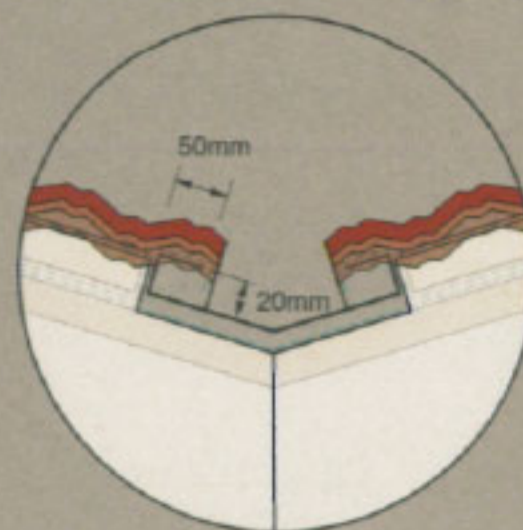

FIG 1.5.2

Plywood Decking

Secure the valley with a clip or by bending a nail over the outer edge. Never nail inside the valley.



2. BATTEN INSTALLATION

2.1 BATTEN SETTING OUT

The most critical factor in the laying out of the tiles is accurate setting out of the tile battens. If this is not adhered to the tiles will not fit correctly (Fig 2.1.1).

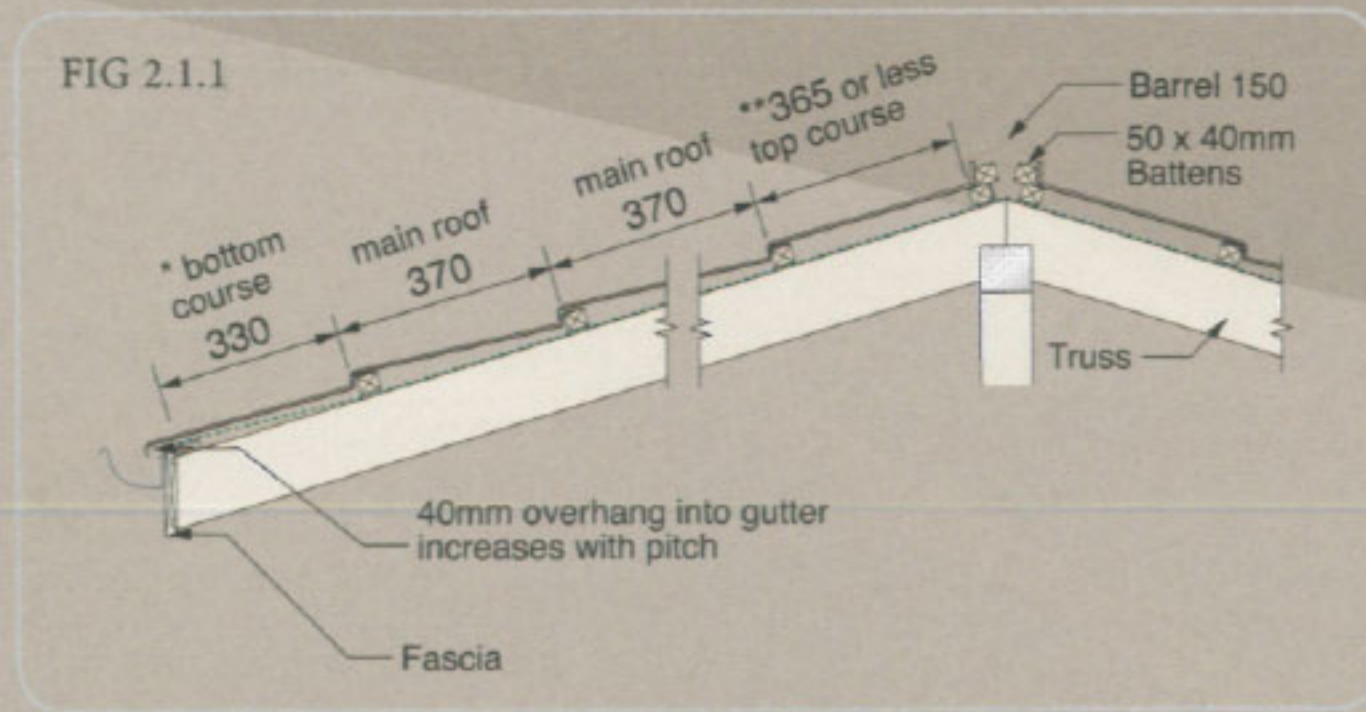

* Variable depending on the type of rainwater collection system used.

** Dimensions will vary depending on rafter length.

In this event, measure up from the outside of the fascia 330mm* to establish the position of the bottom batten (Fig 2.2.2) and, using the measuring rod, measure up the rafters instead of down, to position the remaining battens (Fig 2.2.3).

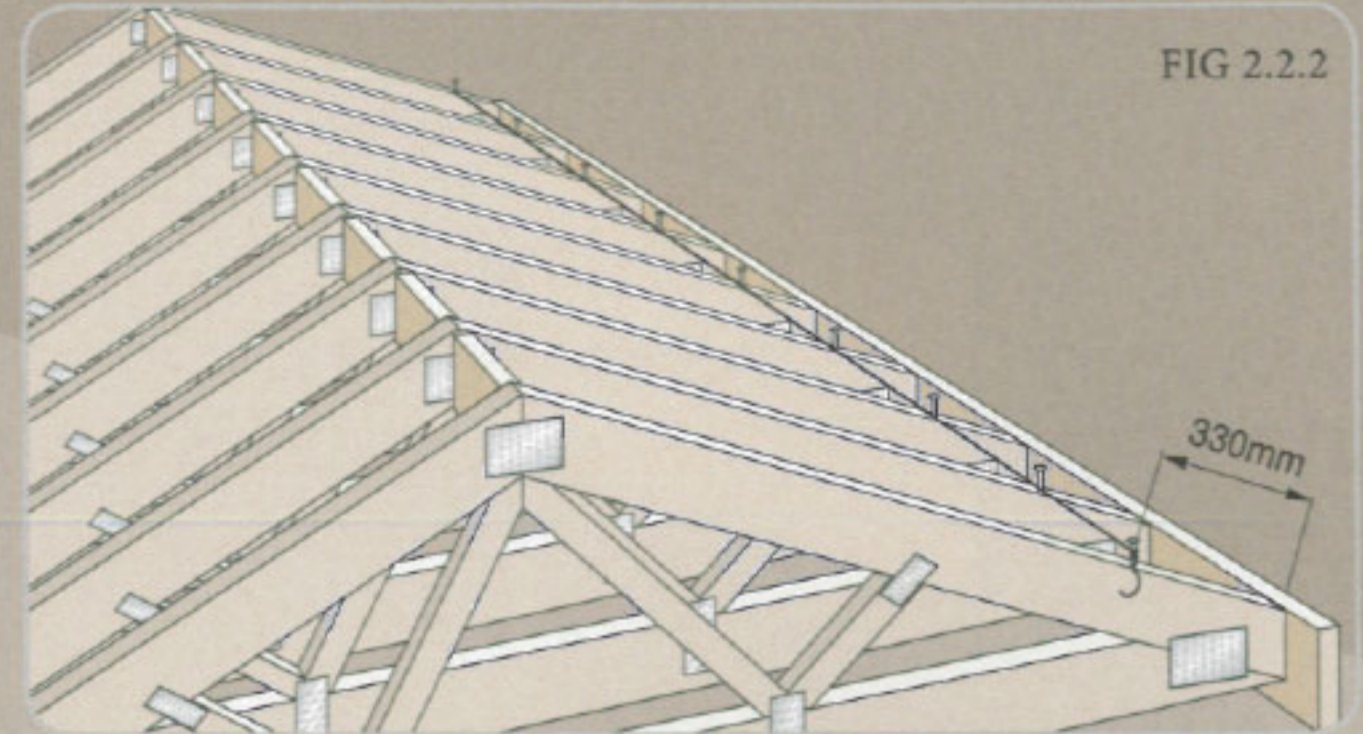

* Variable depending of the type of rain collection system used.

2.2 BATTEN INSTALLATION PROCEDURE

If the rafter suits a full course of tiles, before installing any battens, measure down 365mm from the ridge on the last full rafter at each end of the building, and tack a nail at these points. Run a string line from one nail through to the other. On each of the remaining rafters tack a nail at the string line (Fig 2.2.1).

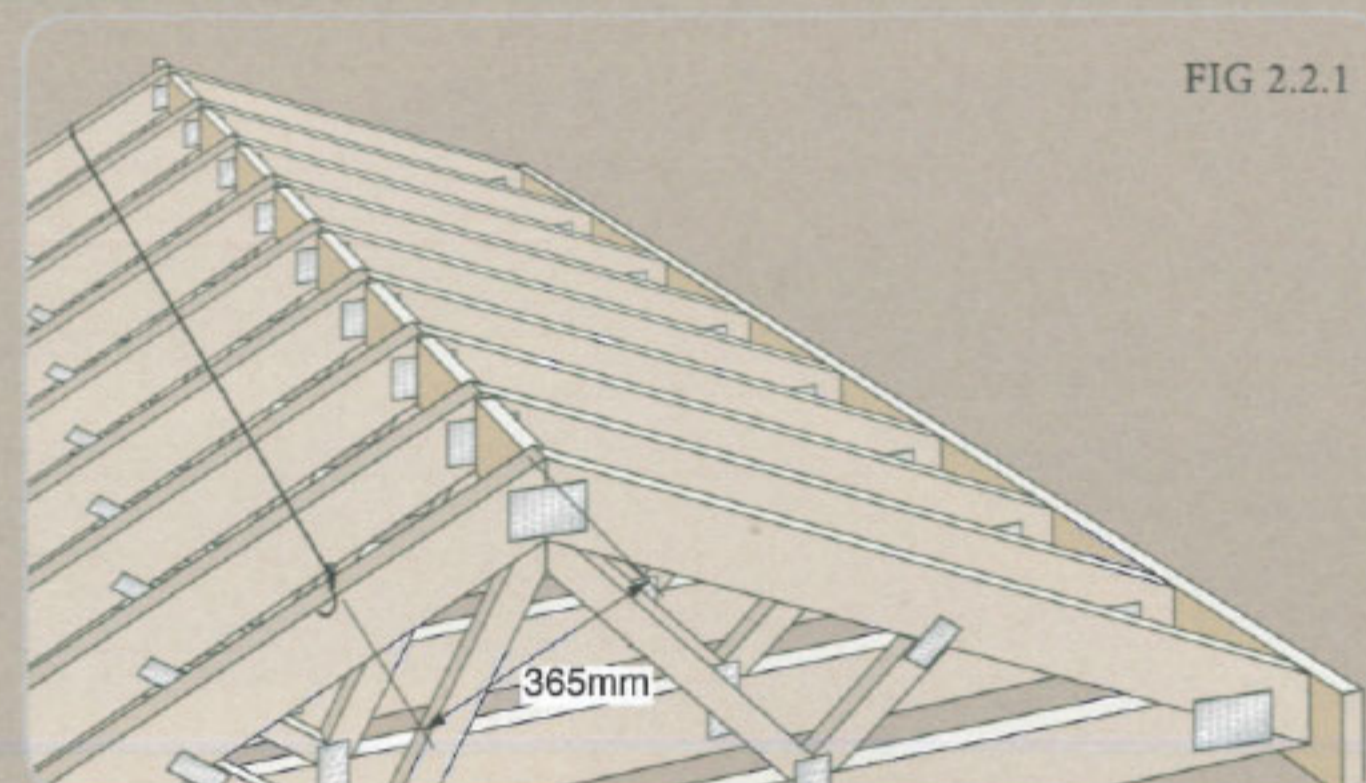

FIG 2.2.1

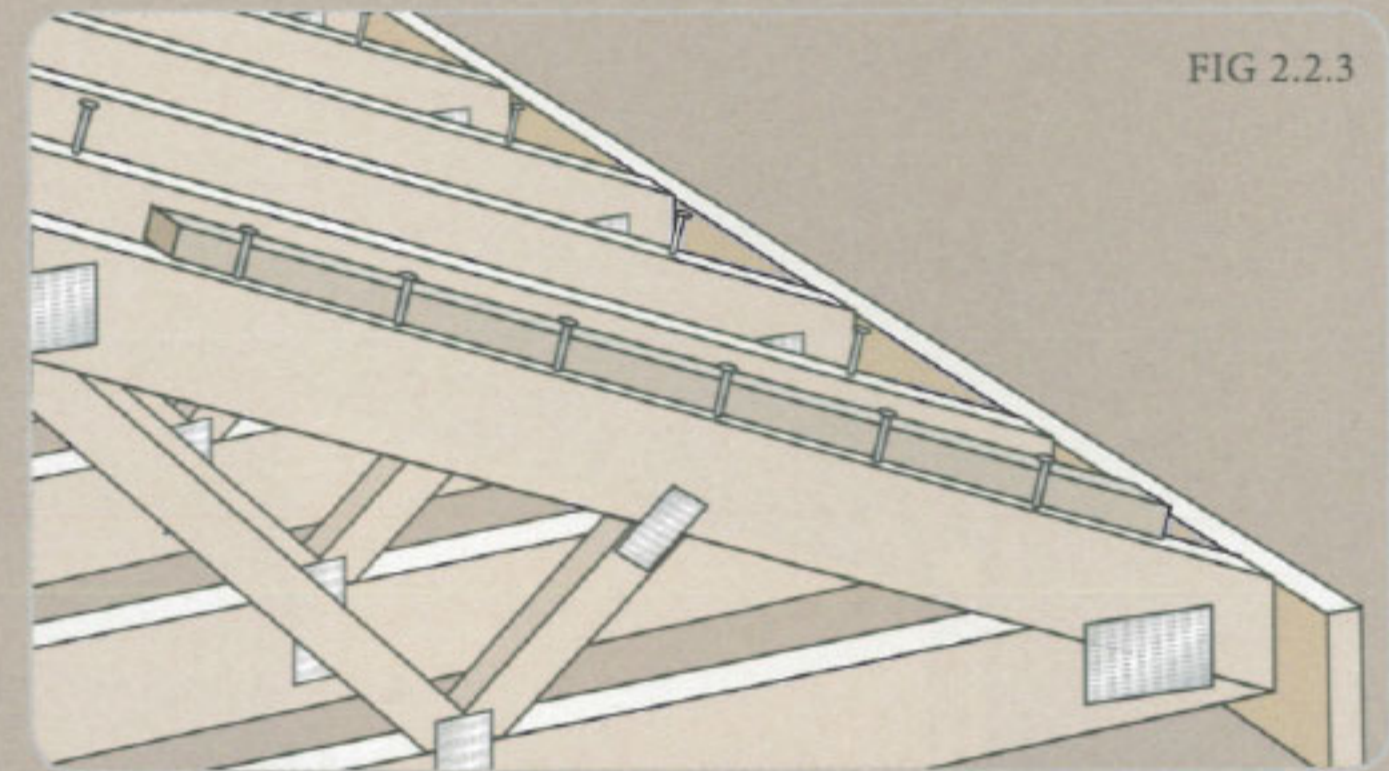

FIG 2.2.3

Load all the battens on to the roof and lay them in rows across the rafters, against marking nails. Ensuring joints are staggered (Fig 2.2.4), cut the battens to length so that they butt together on top of a rafter. Hold the batten firmly against the marking nails and nail through each batten into the rafter. Once installed, pull out the marking nails and use them to install the next batten.

Using the measuring rod, hook over the nail closest to the ridge and run the measuring rod down each of the rafter lengths. Tack a nail in each slot as marking nails (Fig 2.2.3).

Use the batten fixing nails which can later be used for fastening the battens.

An additional batten should be placed immediately behind the fascia for fixing the bottom course of tiles.

If the rafter length does not accurately suit a full course of tiles, the top course will have to be cut and bent to suit, requiring the space of the top batten from the ridge to be less than the usual 365mm.

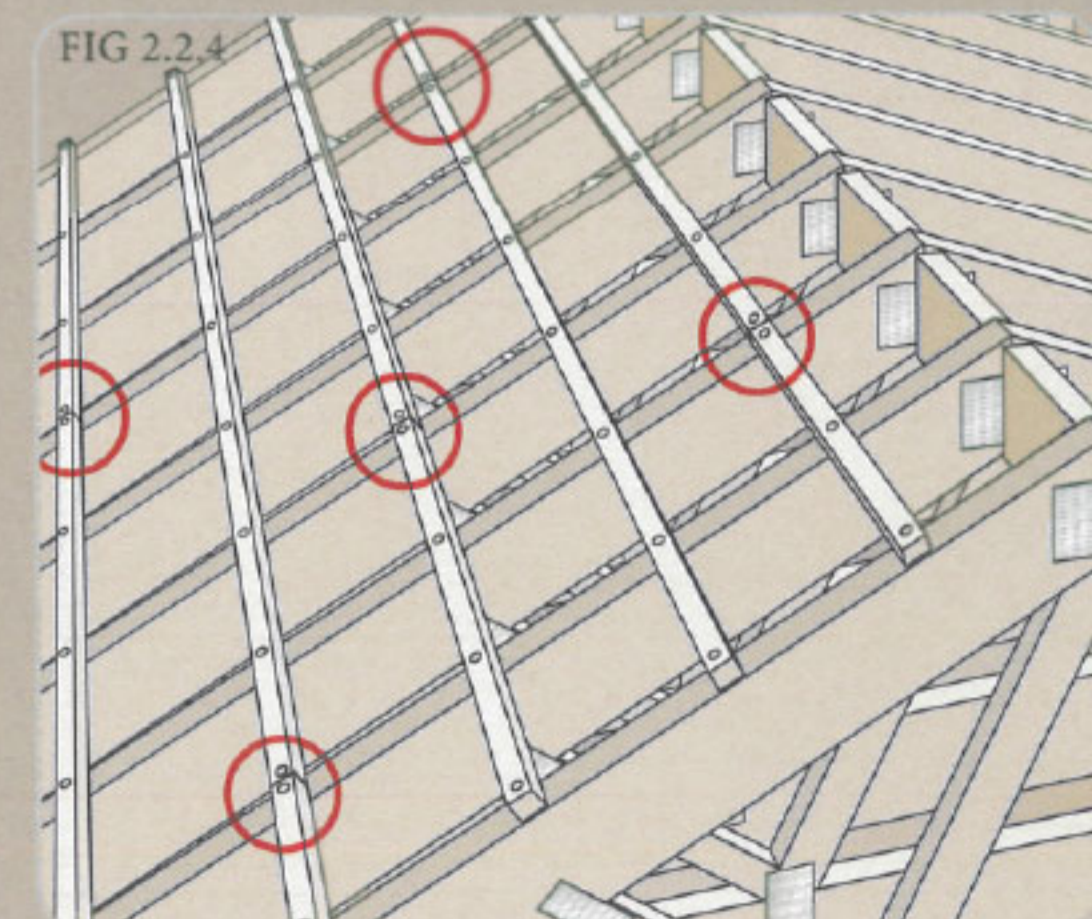

FIG 2.2.4

3. TILE INSTALLATION

3.1 TILE LAYING

Tiles can be interlocked either right over left, or left over right, but should be laid with the laps facing away from prevailing winds or from discharging rainwater pipes or valleys. Where possible, the tiles should also be laid with the laps facing away from the normal line of sight.

Tiles are laid by lifting both tiles in the course above and sliding the next course under the nose of the tiles already in place (Fig 3.1.1).



NOTE: In areas prone to cyclones and hurricanes, installation must meet local standards and bylaws and nailing should be at 8 points per tile.

3.3 NAILING/FASTENING TECHNIQUE

The person nailing should stand on the tile being installed facing the fascia and nailing as shown. Gun nailers can also be used to securely fasten the tiles (Fig3.3.1).



3.2 NAILING/FASTENING

The correct position for nailing tile battens is shown below (Fig 3.2.1). Tiles are secured by nailing through the front downturned flanges into the side of the batten. Nails should be approximately 60mm to the side of the centre of the pan of the tile and close to the bottom of the downturned flange (Fig3.2.2). This ensures good holding of the tile and ample penetration of the nail at the same time restricting nail penetration to a maximum of two thicknesses.

3.4 GABLE ROOF PROCEDURE

Lay the second to top course of tiles from gable end to gable end, turning the edge of the end tiles up against the barge battens. Tack these tiles temporarily in position through the flat of the back edge sitting on the batten. Starting from the course already laid, lay the tiles two courses at a time from end to end. The person laying the tiles should be two courses ahead of the person nailing.

NOTE: The appearance of straight gable roofs can be improved if the tile laps are staggered down the roof, using part tiles at the gable ends.

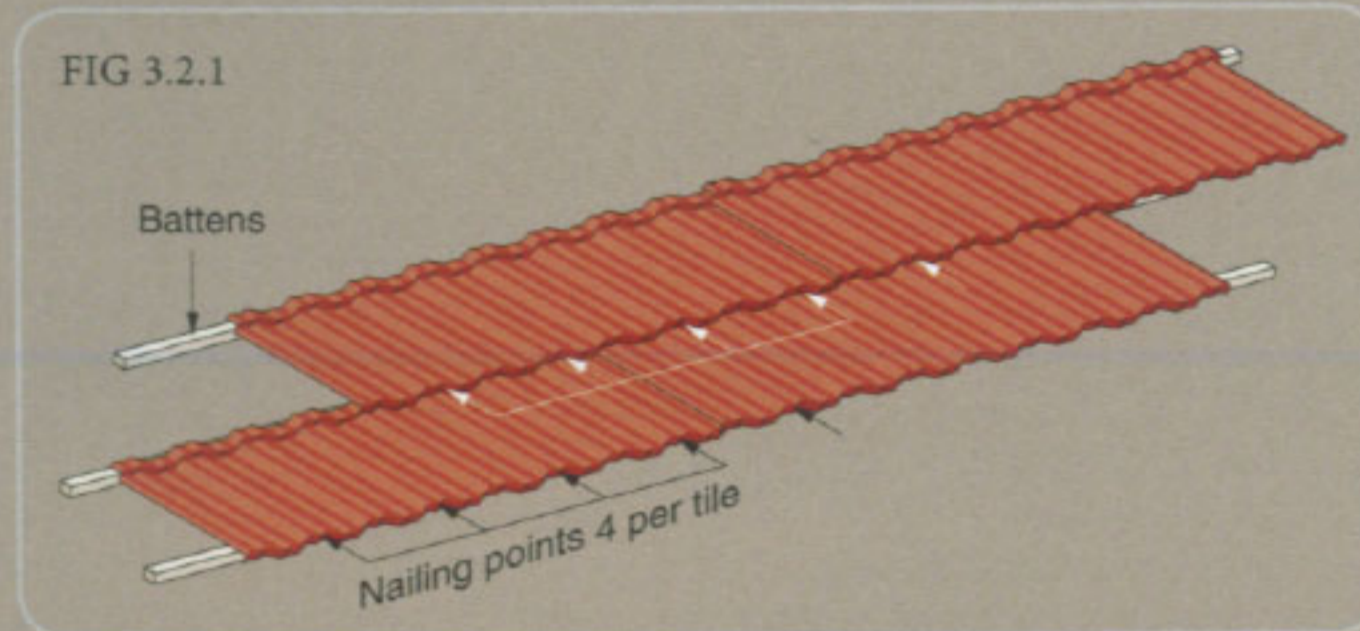

3.5 HIP ROOF PROCEDURE

On the second to top course, lay the top corner of the first tile 150mm from the hip board. Continue to lay tiles towards the outer hip until the last full tile will fit.

Secure these tiles by tacking through the back flange. Lay subsequent courses two at a time, both starting about the same distance from the hip board.

Care should be taken to line up the corrugations. To reduce waste, use part tiles to complete rows within approximately 150mm of the hip board.

This allows each end of a full tile to be cut and bent to fill the gaps.

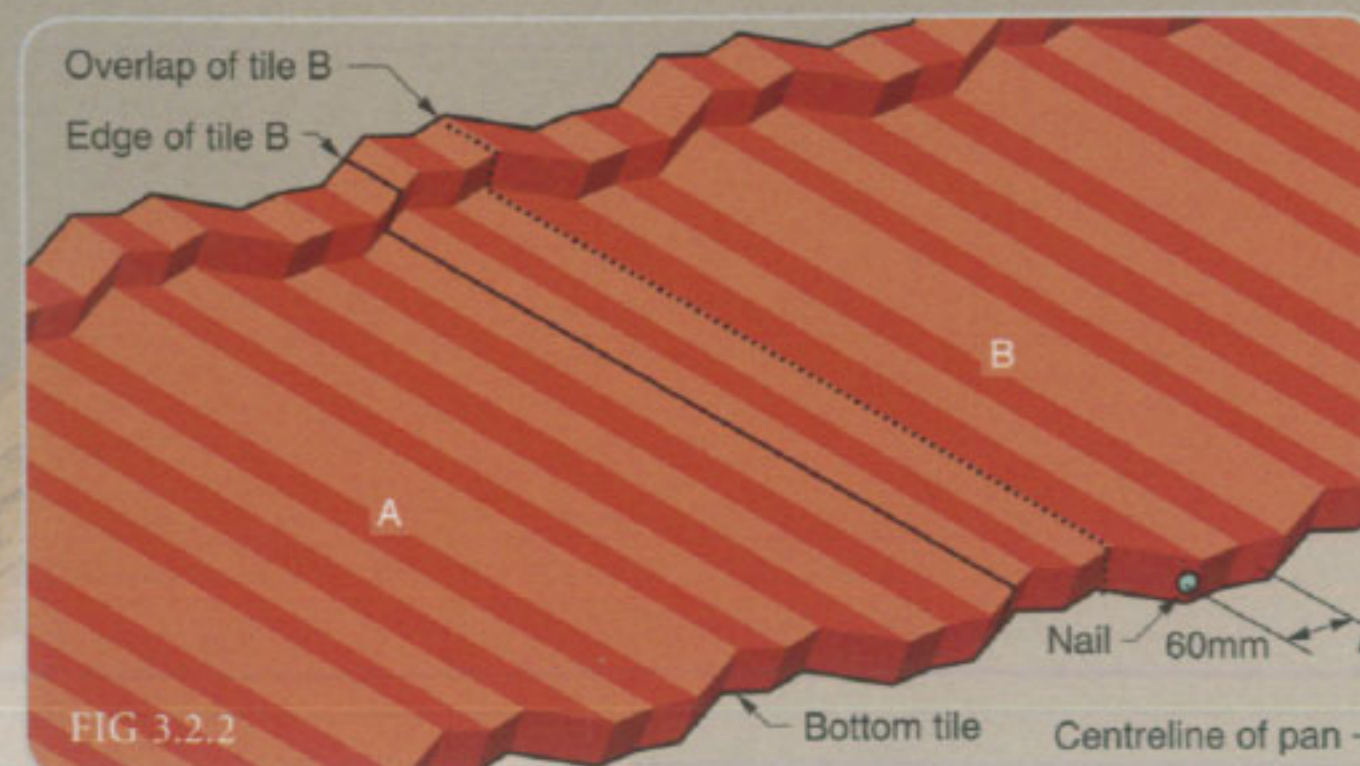

3. TILE INSTALLATION

3.6 TILE INSTALLATION – RIDGES

Measure the distance (A) from the last tile to the ridge board (Fig 3.6.1 & 3.6.2). Add 40mm to the measurement (turn up allowance) and mark the tile to be cut (Fig 3.6.3).

FIG 3.6.1

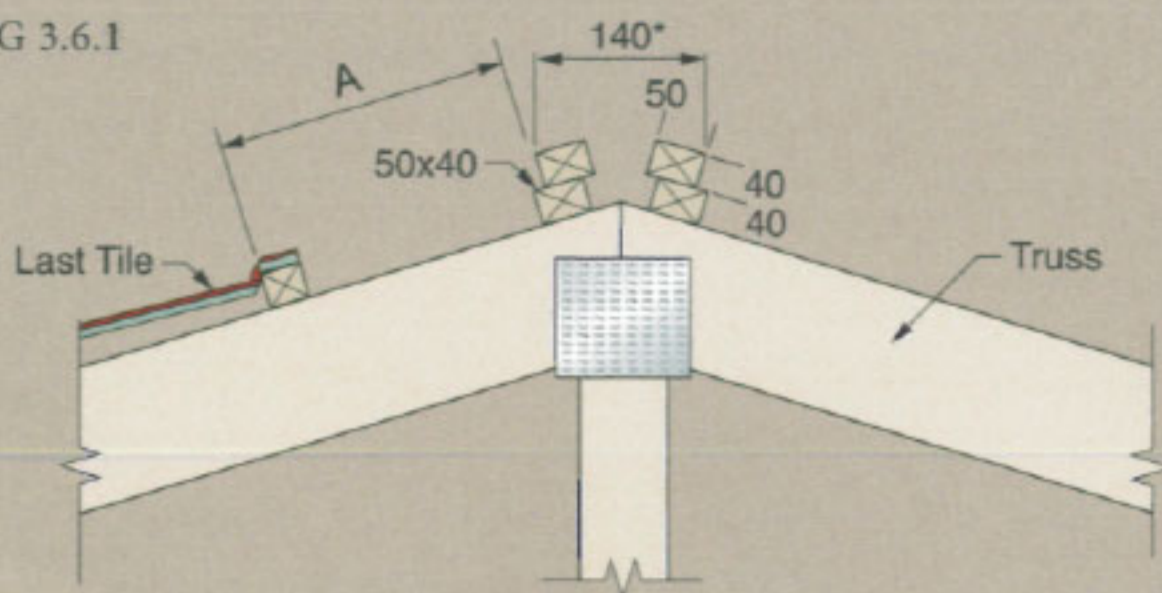

* dimension will vary depending on roof pitch

FIG 3.6.2

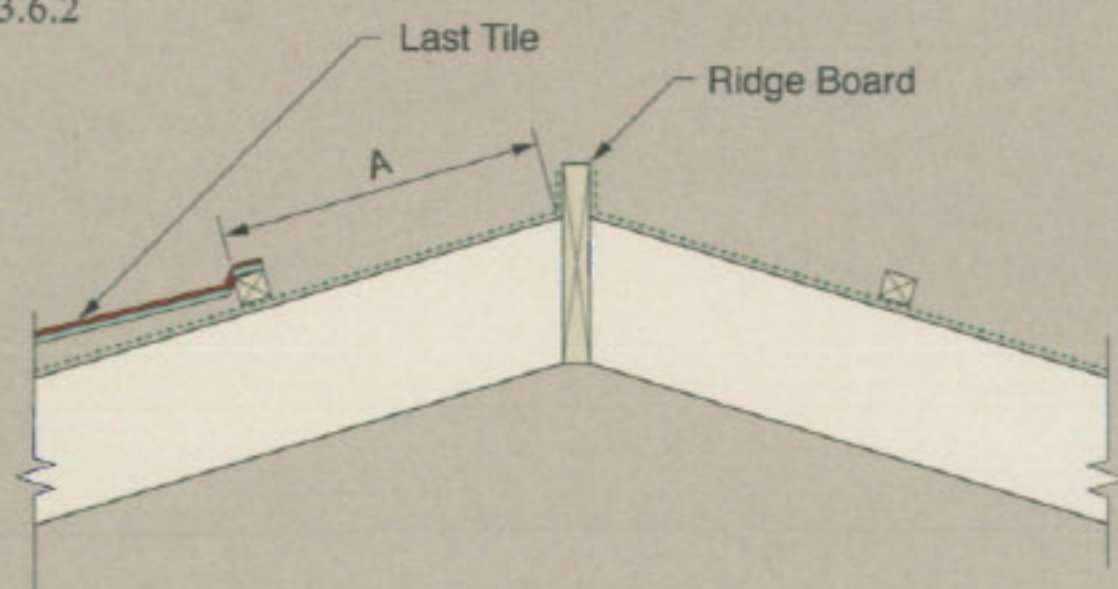

FIG 3.6.3

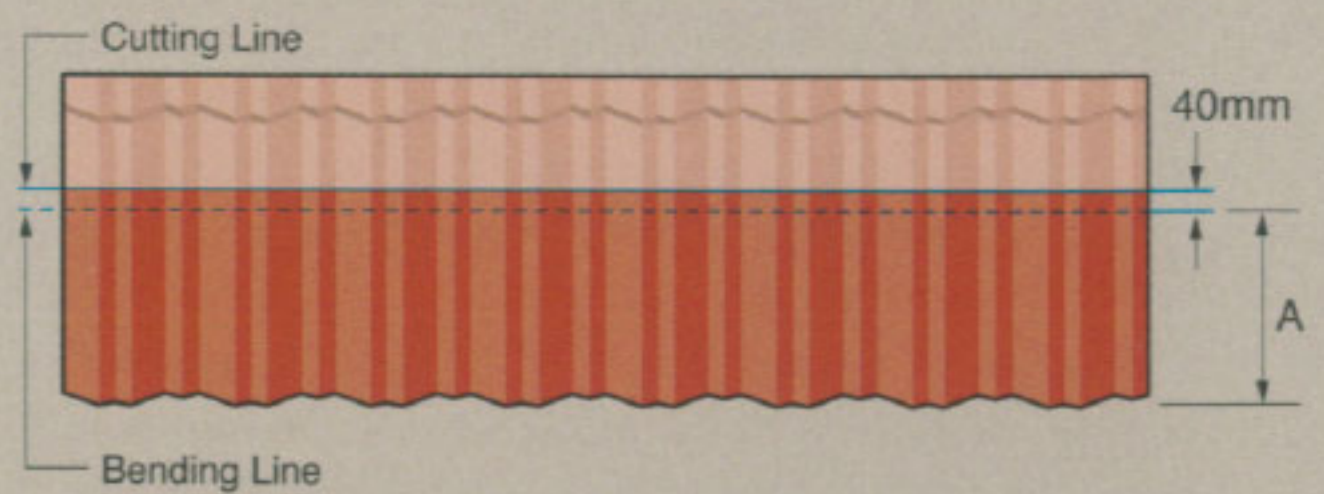
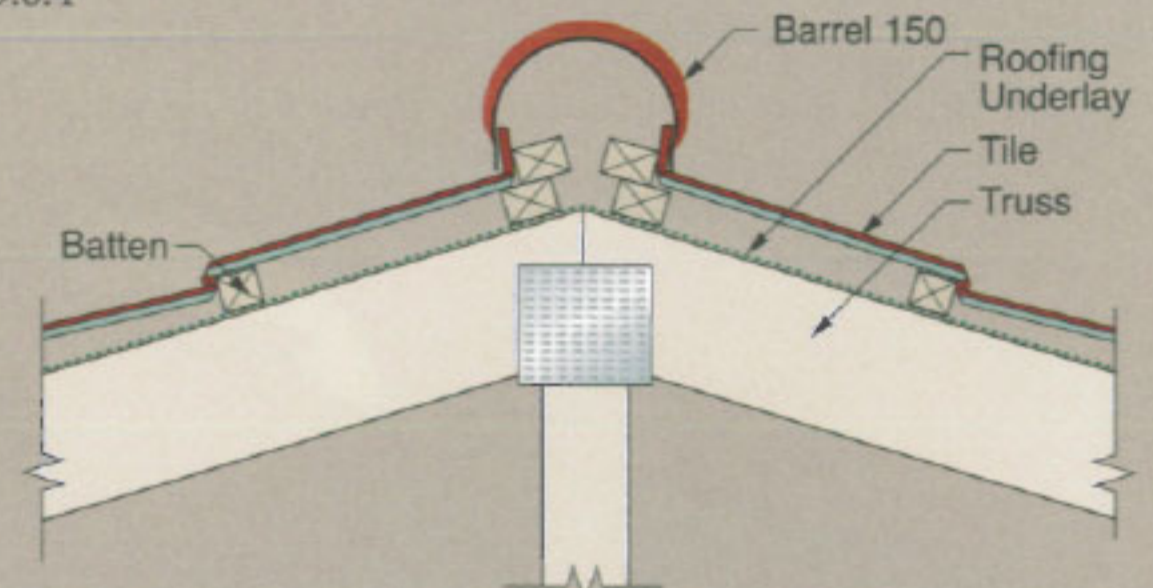

FIG 3.6.4



Place the full-tile in the long-tile bending attachment which can be bolted to the bender. Line up the marks showing the bend line and bend the tile upwards. Tiles can be bent either with the bender or, depending on the length, with the full-tile bending attachment. Finally, cut along the marked cutting line using the guillotine or hand shears.

NOTE: It is essential to bend the tile before cutting to avoid tile distortion. Install the top course of tiles to the ridge board by nailing each tile through its up-stand to the ridge board in 4 places and nailing the bottom edge as previously described.

Ensure that the top course of tiles follows the same pitch as the other courses (Fig 3.6.4).



3. TILE INSTALLATION

3.7 TILE INSTALLATION - HIPS

Measurements are made on the roof, but tiles are normally marked, cut, bent and stacked on the ground. Note the following steps:

- (i) The basic measurement is taken from the last corrugation of the bottom corner of the last tile, to the hip board, along the front edge of the batten (Fig 3.7.1).
- (ii) Measure and mark on the tiles with chalk or similar the required measurements taken from the roof, ensuring the matching corrugation of the overlapping tile to be cut, is taken as the measure starting point (Fig 3.7.1). This forms the Bending Line (Fig 3.7.2). Add to the bending line measurement, the height of the ridge board projection above the tile line. Mark on the tiles with chalk or similar. This forms the Cutting Line (Fig 3.7.2).

Each tile should supply two cut pieces leaving minimum wastage (Fig 3.7.2).

NOTE: As measurements are taken from the face edge of the batten, measurement markings on the tiles should be on this line also.

Cut and bend the tiles according to the measurements determined above. Flattening the nose and headlap before cutting the tile will make the cutting easier. Install all cut tiles by nailing through the turn-up in the hip board, and one or more nails through the front edge into the battens (Fig 3.7.3), starting from the bottom course.

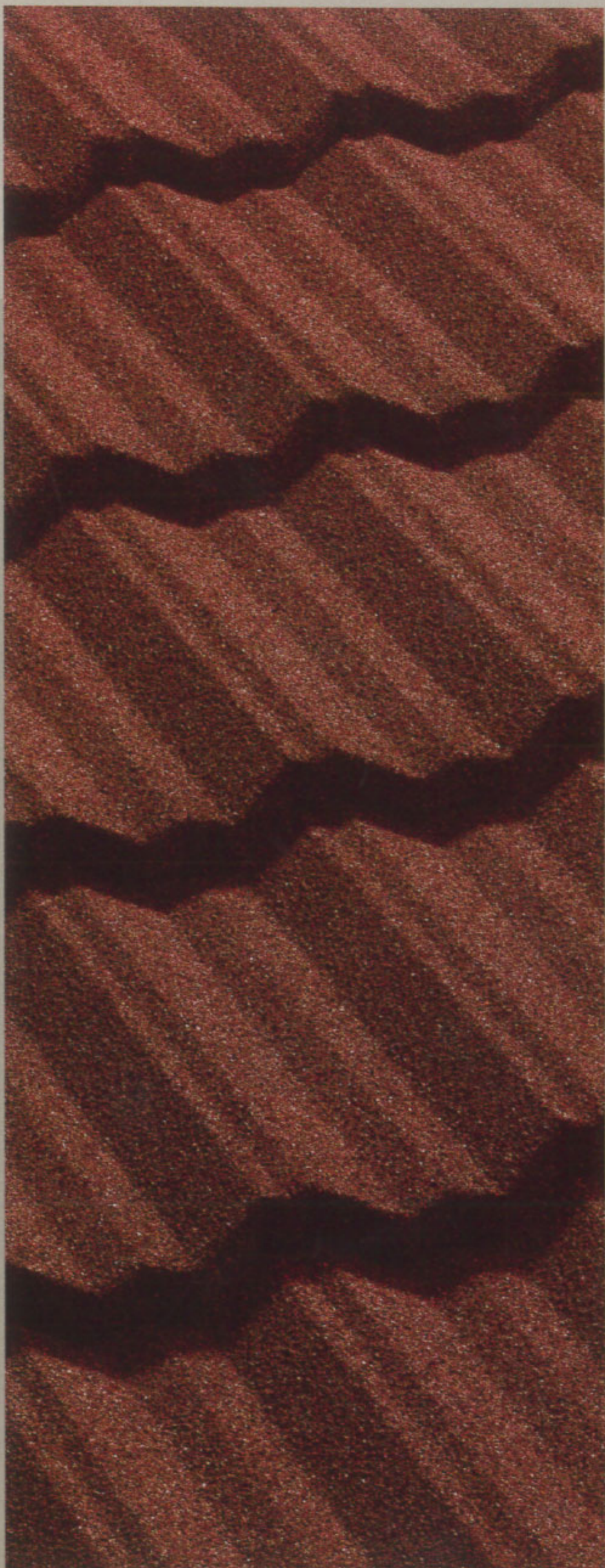

FIG 3.7.1

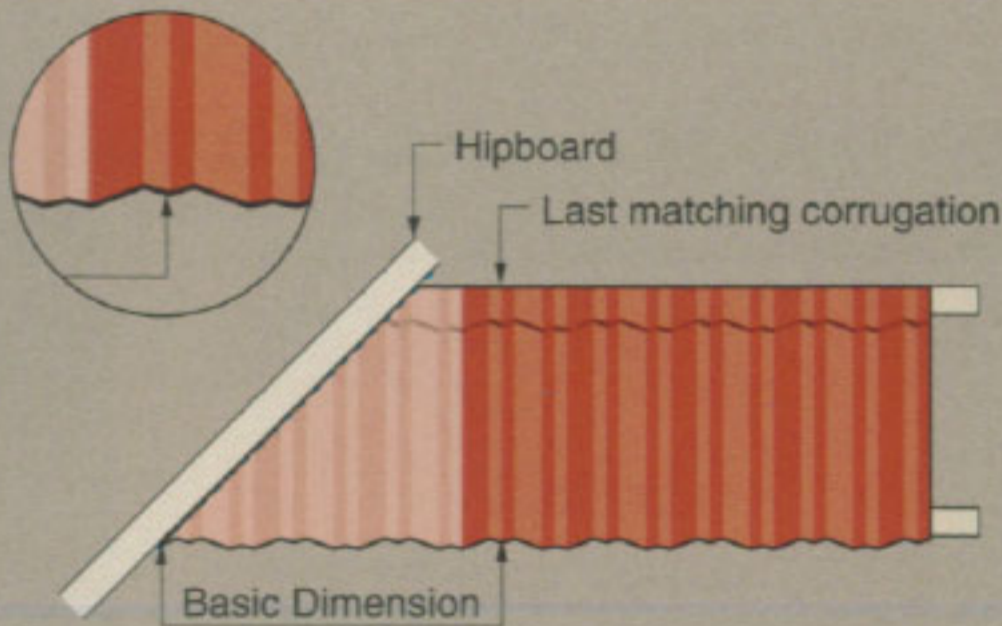

FIG 3.7.2

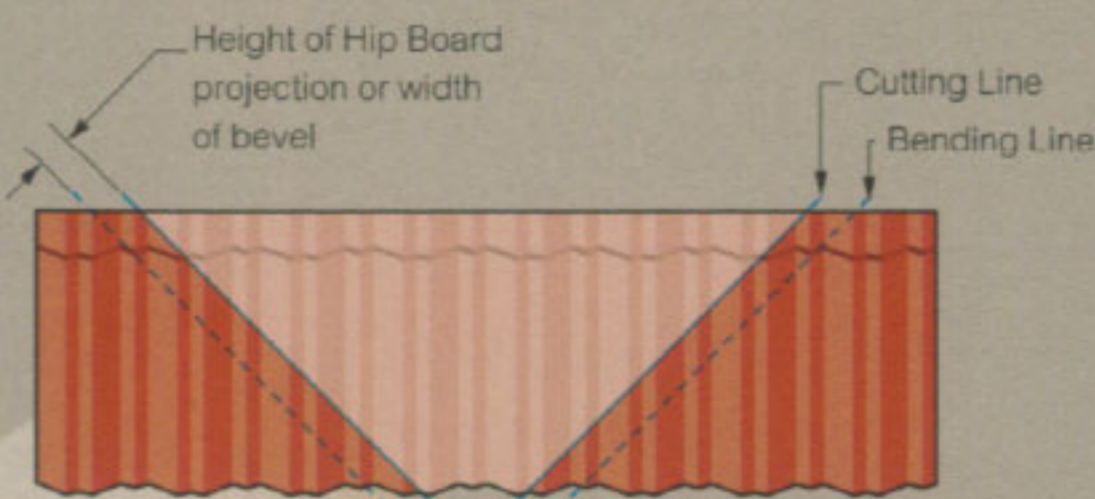
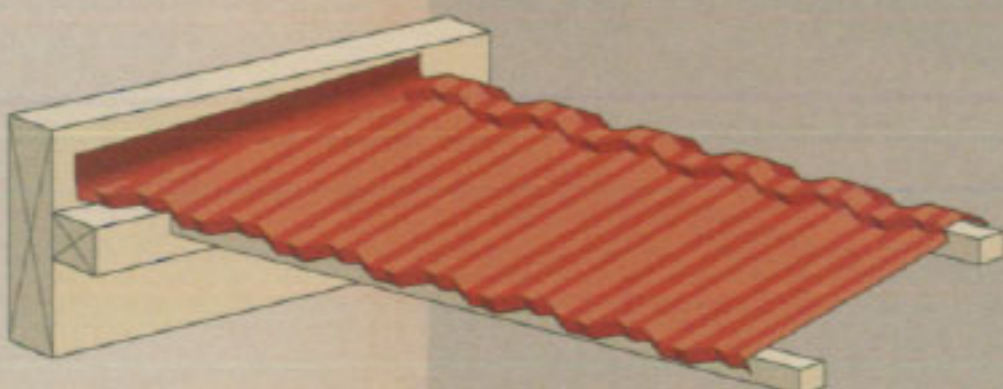

FIG 3.7.3



4. ACCESSORY INSTALLATION

4.1 BOX BARGES

Before installation it is essential that the edge of the end tile is turned up against the barge batten. The Box Barges are then tacked temporarily in place working up the barge board. The overlap should be 100mm. Sight along the barge board to ensure that the Box Barges are straight and true. Adjust if necessary, then drive the nails home. Note that the nails need to be near the bottom edge of the Box Barges to ensure that the bottom edge is firmly positioned against the barge board.

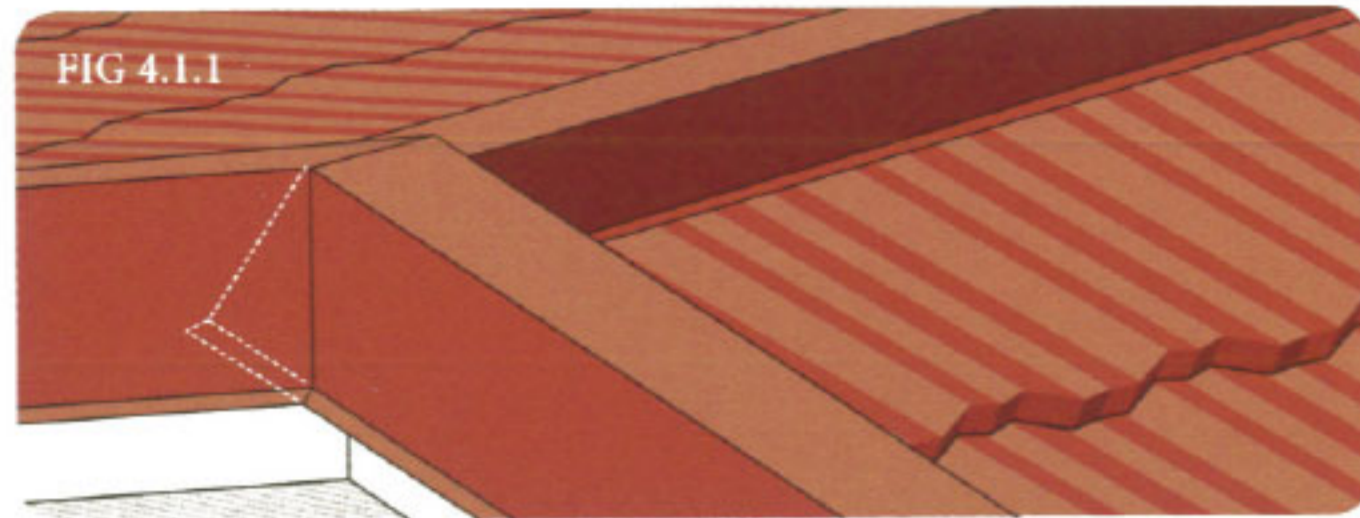

4.2 RIDGE HIPS

Ridge Hip accessories are tapered from end to end, the wider end on one Ridge Hip being pressed down over the narrow end of the next Ridge Hip in line. Lay the Ridge Hips so that they overlap by 100mm. Sight along the ridge to ensure the Ridge Hips are straight and true. Adjust as necessary then drive nails in. Secure with a further two nails on each side of the Ridge Hips.

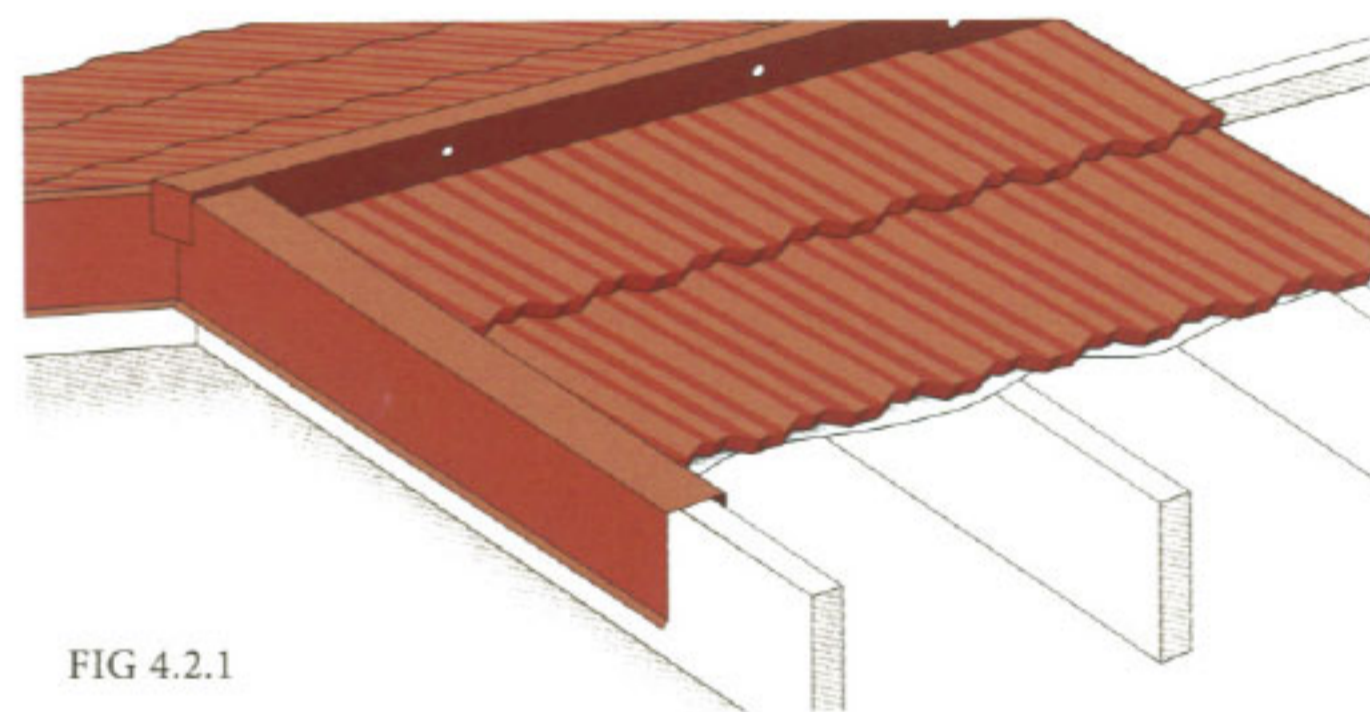

4.3 FLASHINGS

Great care is needed where the roof surface joins a vertical wall such as the case in two storey or split level homes, or where dormer windows protrude from a steep pitch roof.

It is essential to bend the ends of all tile courses up under the flashing (Figs 4.3.1 and 4.3.2). Measure the gap (allowing for overlap) from the last tile to the vertical surface. This gives the bending line. Add 40mm for the Cutting Line. Cut and bend up the tile.

Secure the upturned tiles in place with the upturn against the wall. Do not secure the tile to the wall. (Refer to Figs 4.3.3 and 4.3.4). Nail the side flashing to the wall ensuring that the flashing is hard down

and straight. Alternatively, a hidden gutter is sometimes specified. In this case, the end of the tile battens stop short of the vertical studs by 45mm in order to accommodate the gutter. The gutter is positioned before the roof is installed (Fig 4.3.5 and Fig 4.3.6).

Purpose made flashings may be made to suit wall cladding using Flat Sheet (Fig 4.3.7).

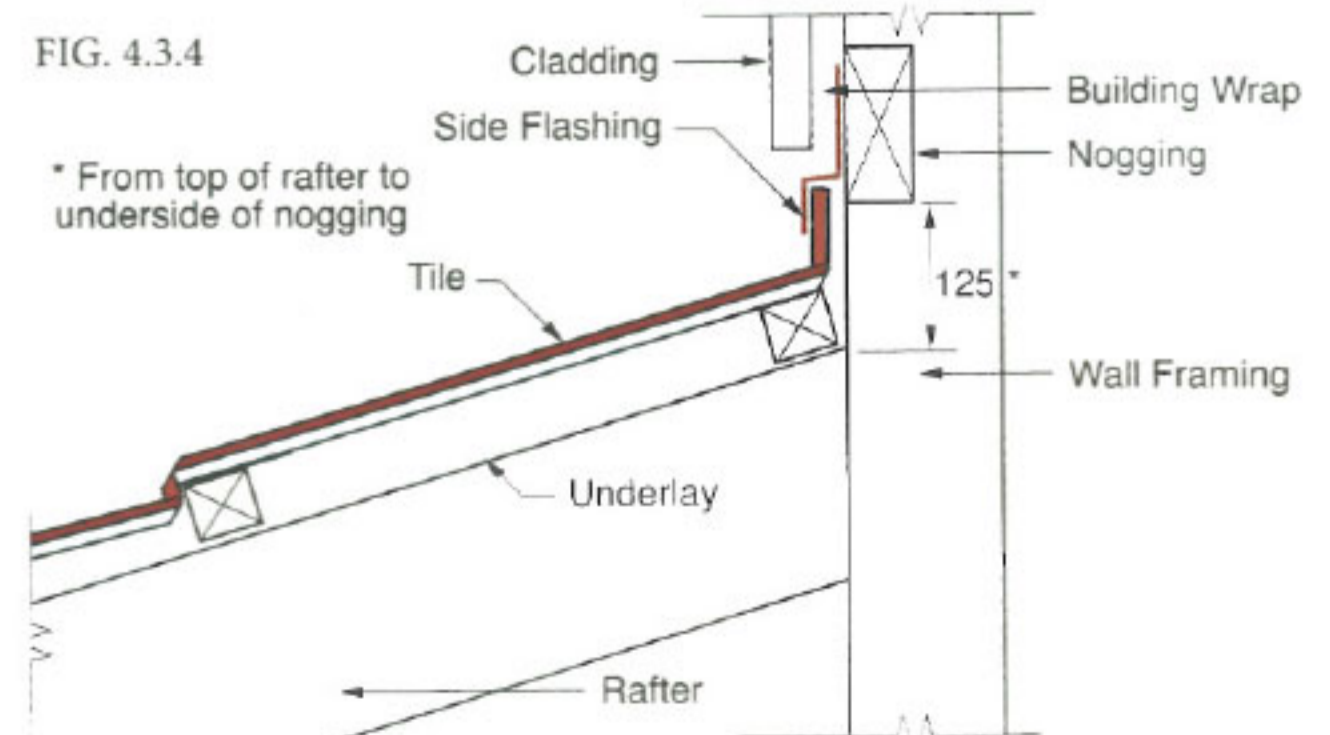
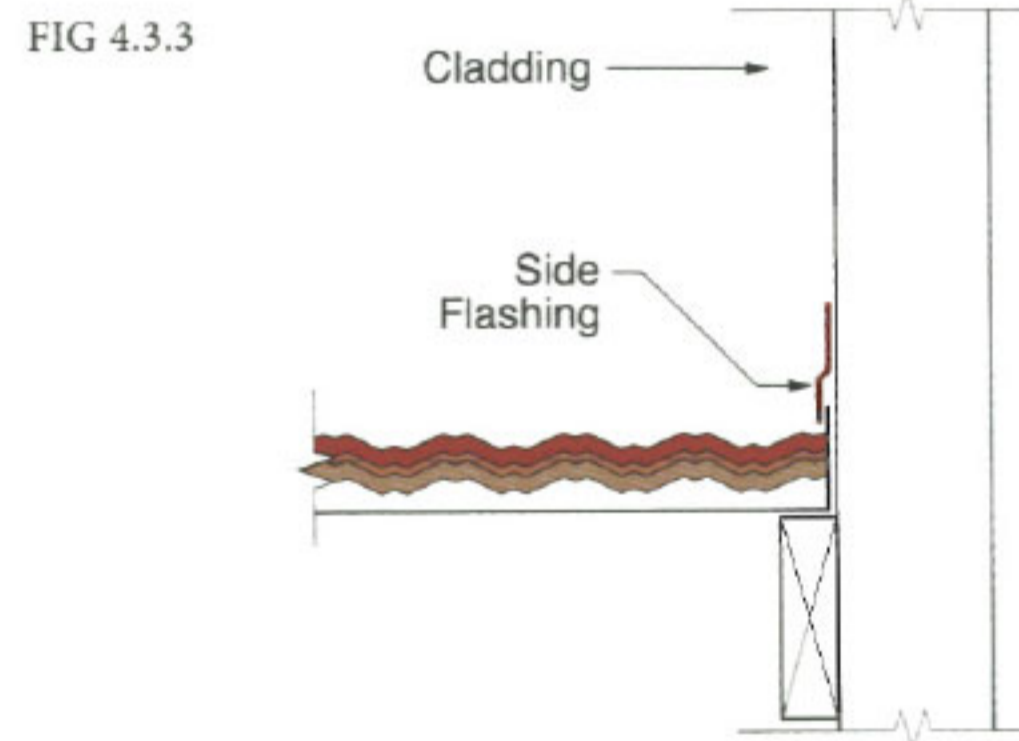
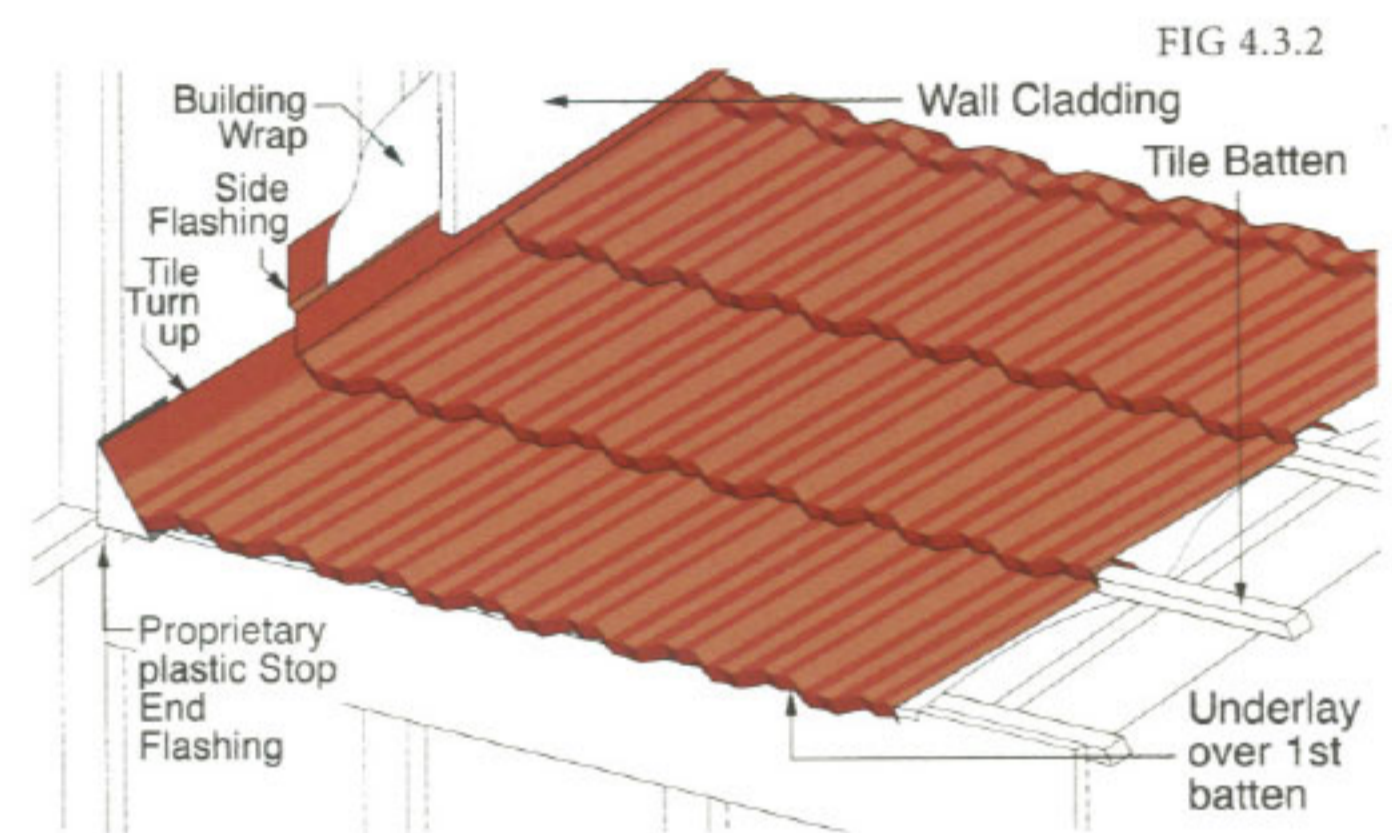
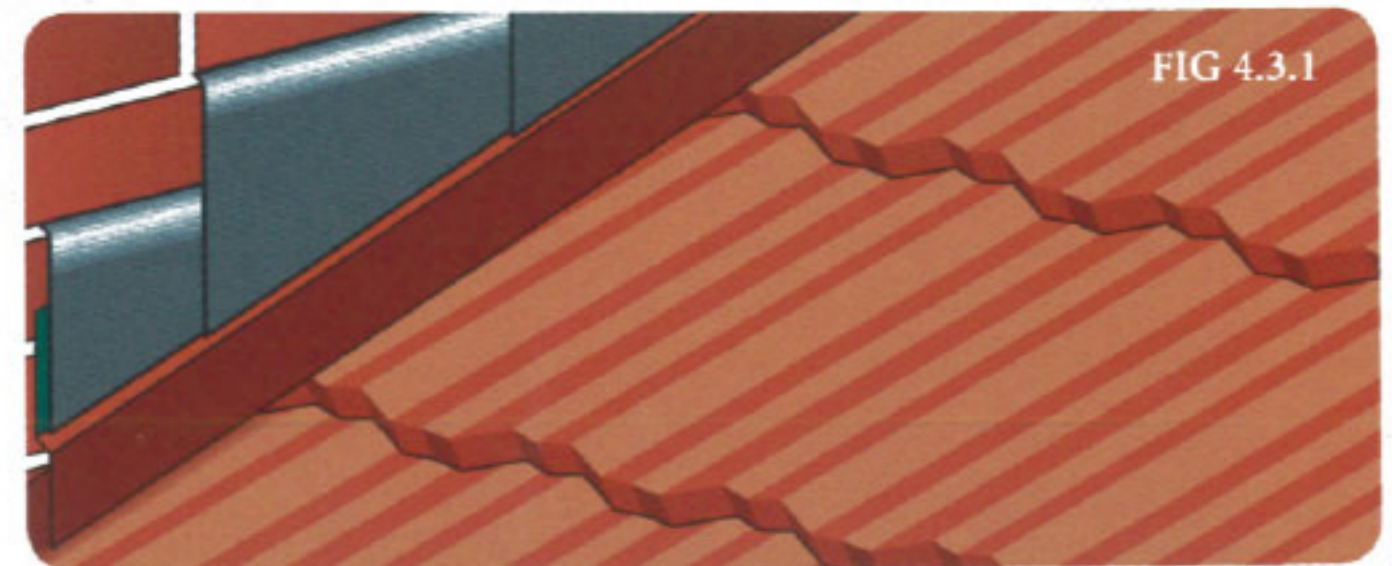

4. ACCESSORY INSTALLATION

FIG. 4.3.5

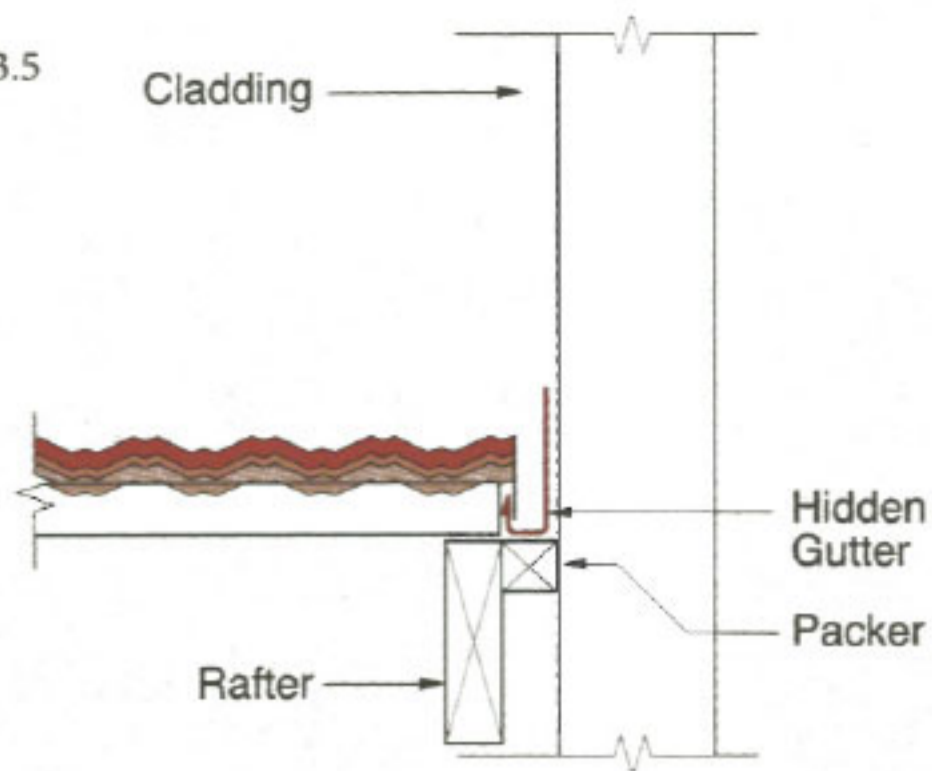

FIG. 4.3.6

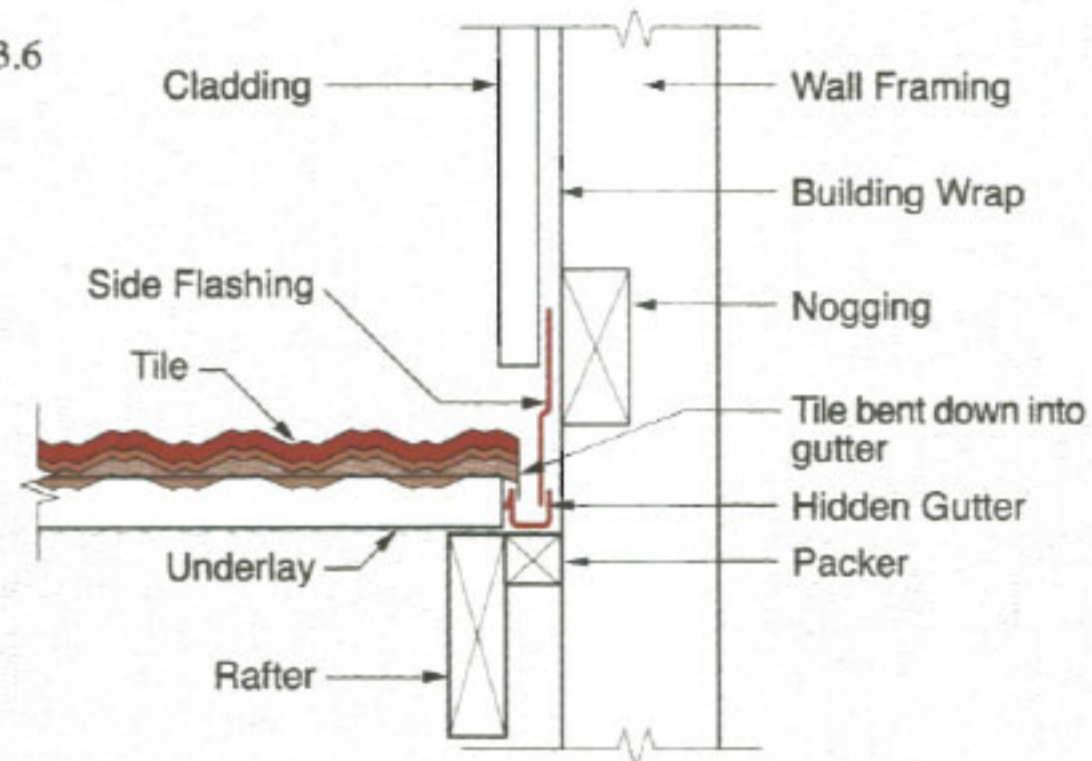
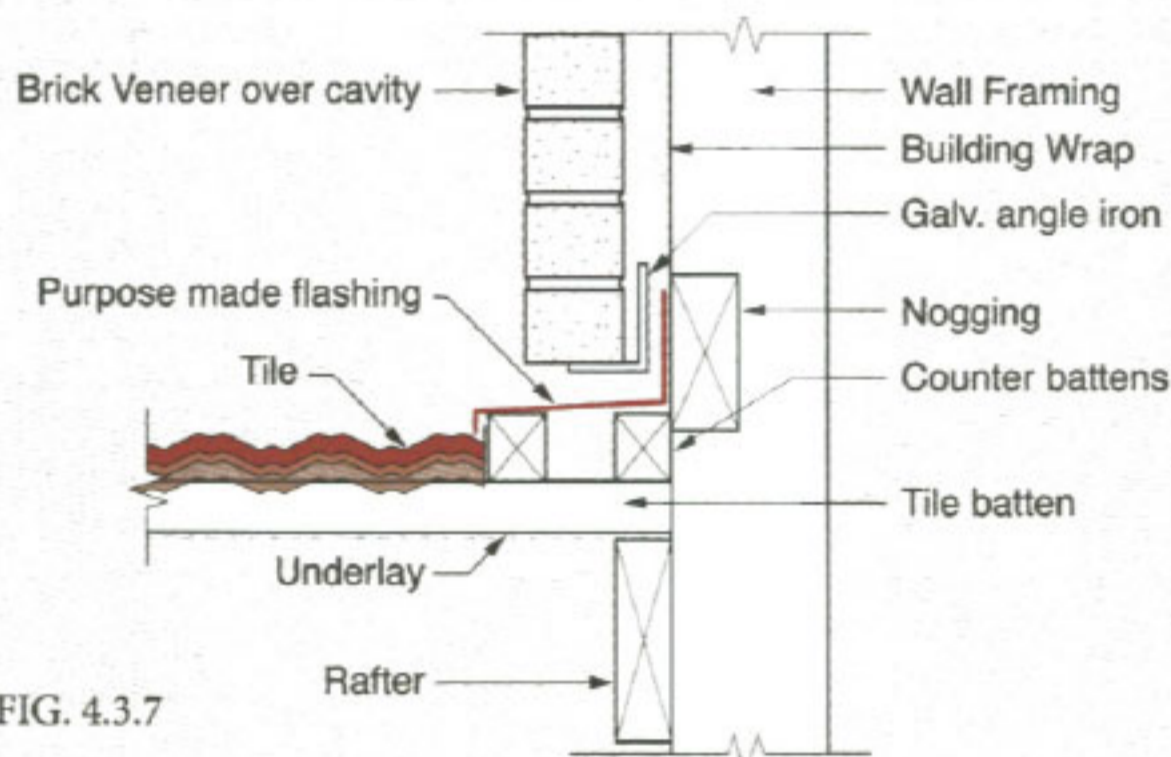

FIG. 4.3.7



BARGES

These Barrel 150 will require reshaping before fitting to ensure a neat weather-tight finish. A 30mm section along the edge should be flattened to fit snugly along the barge batten (Fig. 4.6.1). Start with the lowest Barrel 150 flush with the end of battens and proceed up the barge keeping the Barrel 150 straight. Finish apex neatly by scribing the Barrel 150s together. Nail through each joint into the barge board on the outside and into the barge batten on the inside (Fig. 4.6.2 & Fig. 4.6.3).

RIDGE

Commence by scribing the first Barrel 150 over the hip or barge Barrel 150s and continue laying Barrel 150s along the ridge, ensuring that these are seated straight and firmly down on the tiles below. Nail as for hips.

FIG 4.6.1

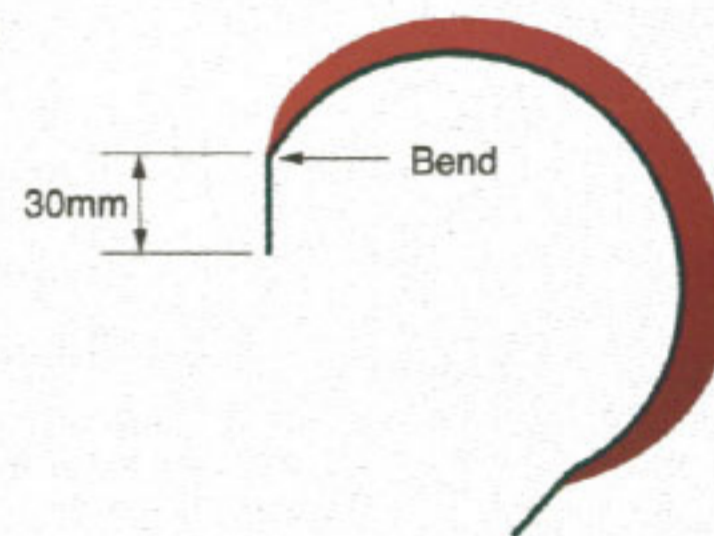

FIG 4.6.2

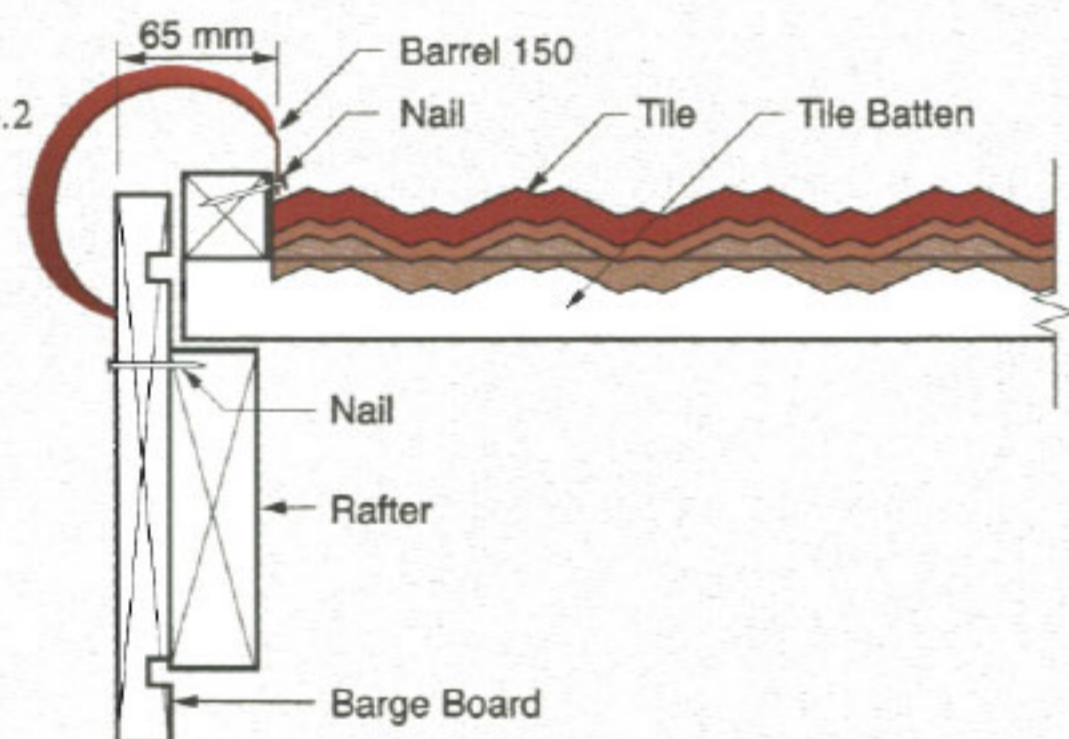
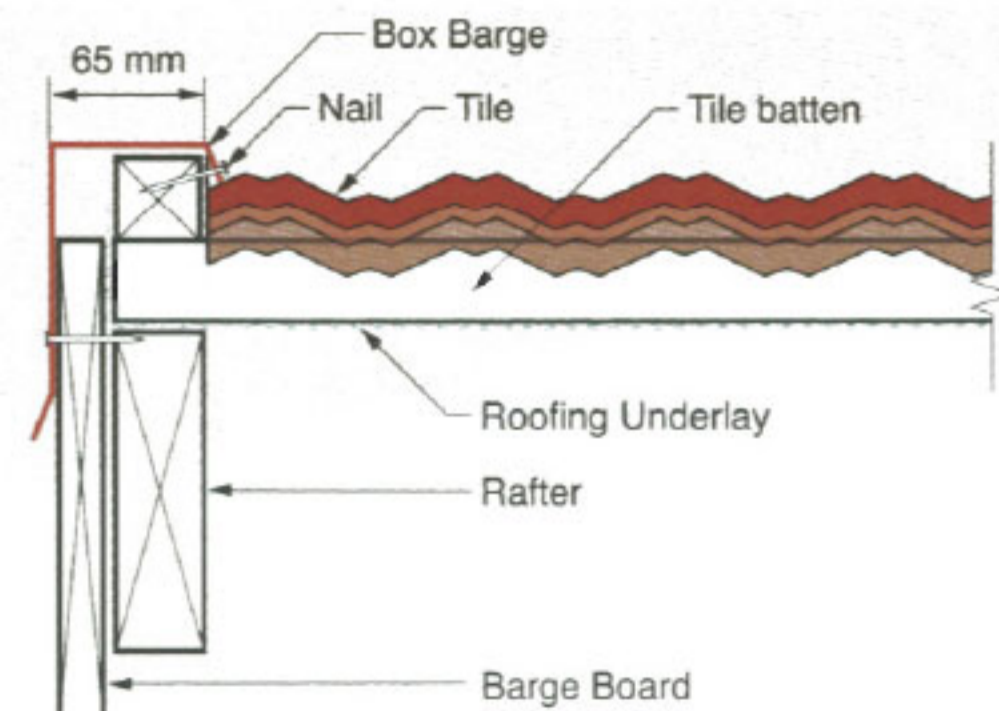

FIG. 4.6.3



4.4 MANSARDS

Where standard accessories are not suitable custom flashings can be made on site using the general purpose Apron Flashing. These can be neatly bent to conform to the shape of the mansard top.

4.5 NAIL HEADS

Touch up all nail heads using the Touch Up Kit if required.

4.6 BARREL 150 ACCESSORIES

HIPS

Starting from the bottom, place the first Barrel 150 accessory over the turned up tiles with the end flush with the end of the hip. Set subsequent accessories progressively up the hip ensuring that they are straight. Nail through each Barrel 150 near the laps and into battens on the hip. The lower end of the Barrel 150 should be closed off by fitting a Barrel End bent to suit at the end of the batten.

5. ESTIMATING DATA

5.1 STRAIGHT GABLE ROOF

- (i) Determine the rafter length (Fig 5.1.1) and calculate the number of courses of tiles from Table 5.1. Always ensure that fractional tiles are counted as whole tiles as these will have to be cut at the ridge board.
- (ii) Determine the overall length of the roof (Fig 5.1.2) and refer to Table 5.1 for the number of tiles required. Ensure that fractional tiles are counted as whole tiles.
- (iii) Multiply tiles (i) x tiles (ii).
- (iv) Multiply result (iii) x 2 when estimating for both sides of the roof.

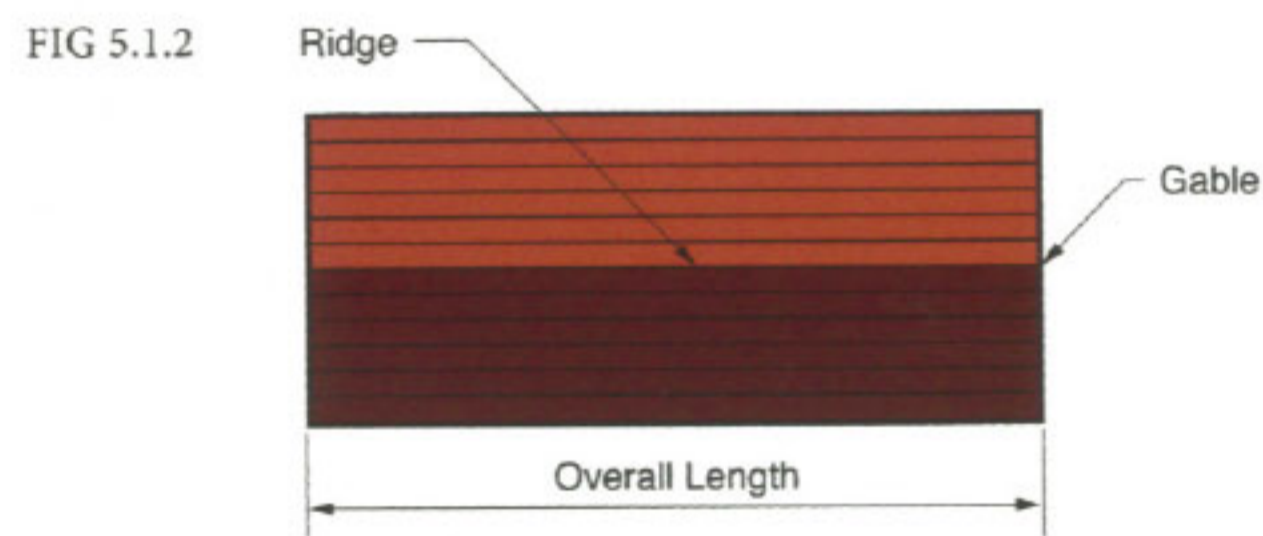
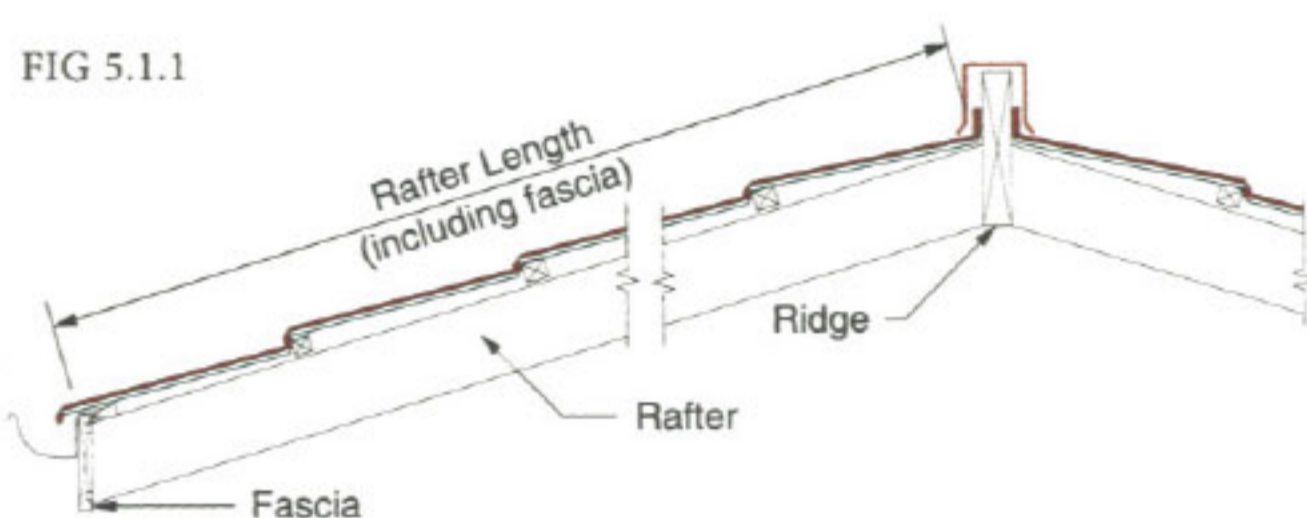

5.2 HIP AND VALLEY ROOFS

- (i) **HIP ROOFS:** Treat the roof initially as a straight gable. Find the overall length (Fig 5.2.1) and refer to Table 5.1 to calculate the number of tiles required for the coverage. Multiply the result by the number of courses of tiles needed to cover the rafter length. Multiply again by two when calculating both sides of the roof. Find the total hip length and using one of the formulae outlined in (iii), calculate the tiles required for the hips. Add this to the tiles required for the body of the roof.
- (ii) **HIP AND VALLEY ROOFS:** First take the section with the longest rafters (section A Fig 5.2.2). From Table 5.1 calculate the requirements for that section and then for the remaining sections (sections B and C Fig 5.2.2). Find the total length of hips and valleys and using the formula outlined in (iii), calculate the additional tiles required for hips and valleys to obtain the total tile requirement.
- (iii) Additional tiles for hips and valleys may be estimated using the following formula: Additional tile quantity = Total hip and valley length in linear metres x wastage factor (where the wastage factor = 1.32 tiles per linear metre).

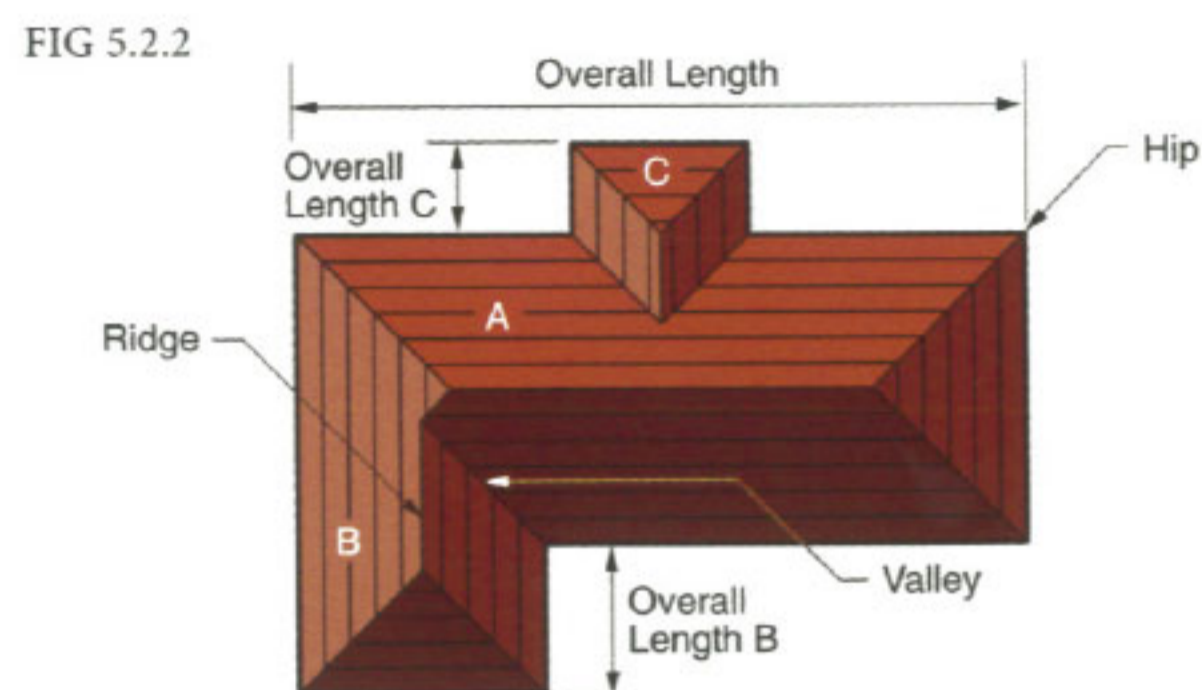
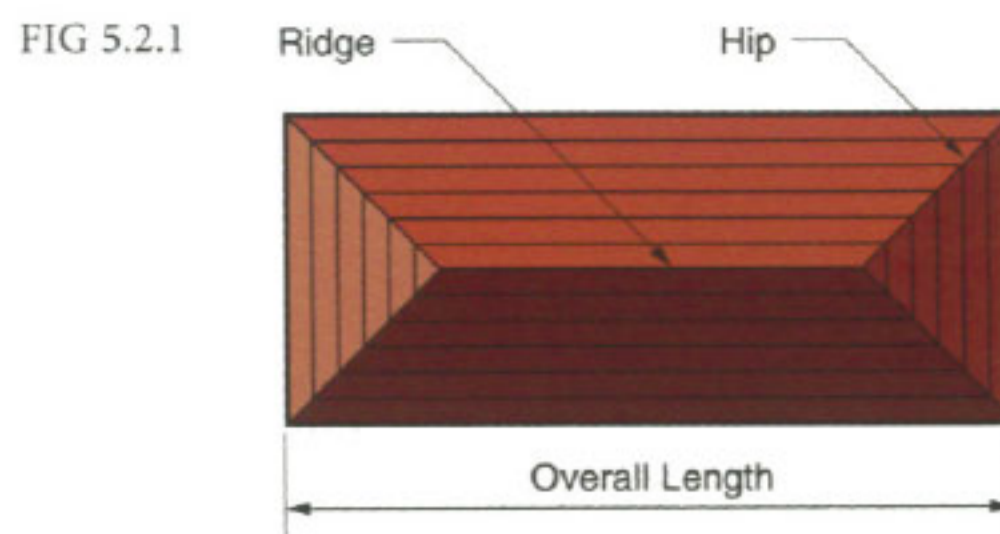

TABLE 5.1

RAFTER LENGTH*		OVERALL ROOF LENGTH	
TO SUIT FULL COURSE OF TILES	NO. OF TILE COURSES	ROOF LENGTH USING BARGE COVERS	NO. OF TILES
mm		mm	
0.345m	1	1.365m	1
0.710m	2	2.622m	2
1.080m	3	3.879m	3
1.450m	4	5.136m	4
1.820m	5	6.393m	5
2.190m	6	7.650m	6
2.560m	7	8.907m	7
2.930m	8	10.164m	8
3.300m	9	11.421m	9
3.670m	10	12.678m	10
4.040m	11	13.935m	11
4.410m	12	15.192m	12
4.780m	13	16.449m	13
5.150m	14	17.706m	14
5.520m	15	18.963m	15
5.890m	16	20.220m	16
6.260m	17	21.477m	17
6.630m	18	22.734m	18
7.000m	19	23.991m	19
7.370m	20	25.248m	20
7.740m	21	26.505m	21
8.110m	22	27.762m	22
8.480m	23	29.019m	23
8.850m	24	30.276m	24
9.220m	25	31.533m	25
9.590m	26	32.790m	26
9.960m	27	34.047m	27
10.330m	28	35.304m	28
10.700m	29	36.561m	29
11.070m	30	37.818m	30

* To be used for estimating purposes only. Tile course quantities for rafter lengths allow for 25mm tile overhang into eaves gutter. For steep pitch roofs and some gutter systems this figure may have to be increased.

* BARREL 150 ACCESSORIES: When using Barrel 150 Accessories, the ideal rafter length allowing for full courses of tiles is 50mm longer than specified above.

5. ESTIMATING DATA



5.3 ESTIMATING ACCESSORIES

When calculating accessory requirements a small allowance should be included to compensate for wastage.

- (i) **RIDGE HIPS:** Determine the length of ridges and/or hips. Divide by the linear coverage per Ridge Hip (i.e. 1.9m) to calculate the number of units required.
- (ii) **BOX BARGES:** Determine the length of barge board. Divide by the linear coverage per Box Barge unit (i.e. 1.9m) to calculate the number of units required.
- (iii) **SIDE FLASHING AND FLAT SHEET FLASHINGS:** Determine the overall length of flashing required. Divide by the linear coverage per flashing unit (i.e. 1.9m) to calculate the number of flashing units required.
- (iv) **BARREL 150s:** Determine the total length of ridges, hips and barge boards, to be covered. Divide by the linear cover of each unit (i.e. 0.37m) to calculate the number of Barrel 150s required.

5.4 ESTIMATING BATTENS FOR NEW ROOFING

Provide 3 linear metres of batten per square metre of roof.

NOTE: Where laying over solid decking provide 2.7 linear metre of battens per square metre of roof.

5.5 ESTIMATING BATTENS FOR OVERLAY RE-ROOFING

Provide 5 linear metres of batten per square metre of roof.

5.6 ESTIMATING TILE NAIL QUANTITIES

Provide 1 kilogram of nails per 22 square metres of roof.

6. GENERAL INFORMATION

6.1 LIST OF COMPONENTS

All dimensions and weights given are nominal.

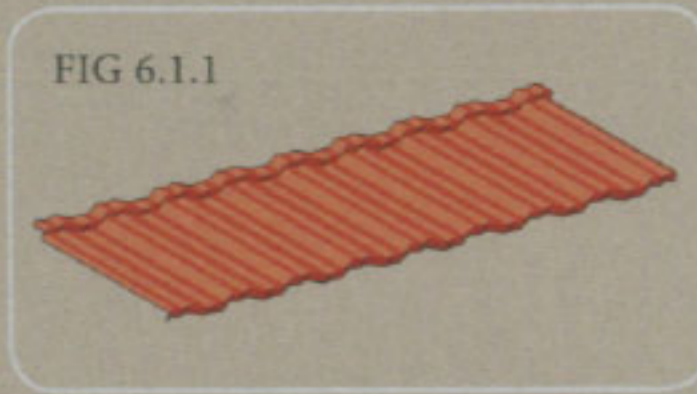

TILE	
Overall length	1320mm
Length of cover	1257mm
Width of cover	370mm
Upstand	28mm
Roof cover/tile	0.465m ²
Coverage	2.2 tiles/m ²
Weight/ Gerard unit	3.2kg
Weight/Colortile unit	2.1kg

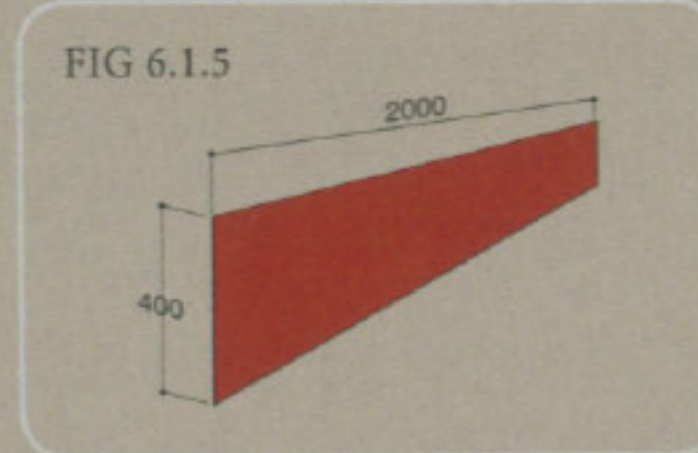

FLAT SHEET	
Overall length	2000mm
Width	400mm
Weight/ Gerard unit	4.2kg
Weight/Colortile unit	2.7kg

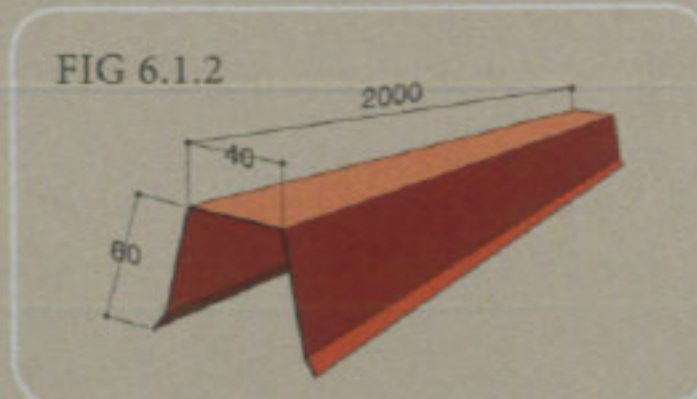

RIDGE HIP	
Overall length	2000mm
Length of cover	1900mm
Downturn	62mm
Width	35mm
Weight/ Gerard unit	2.0kg
Weight/Colortile unit	1.3kg

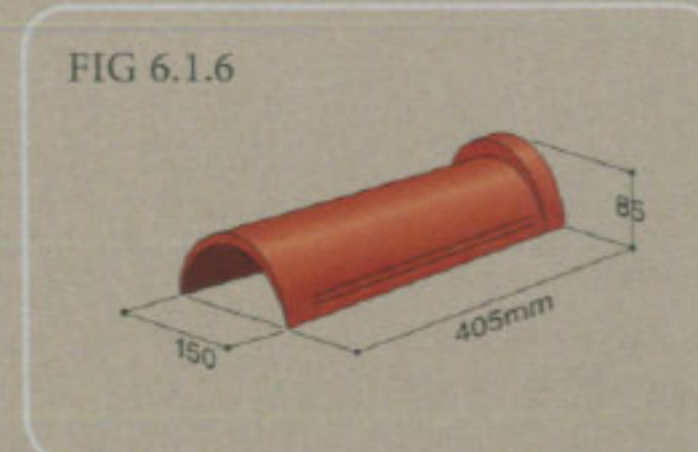

BARREL 150	
Overall length	400mm
Length of cover	370mm
Weight/ Gerard unit	0.6kg
Weight/Colortile unit	0.4kg

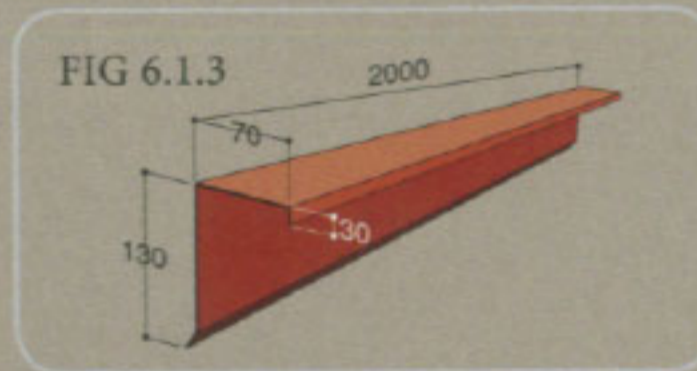

BOX BARGE	
Overall length	2000mm
Length of cover	1900mm
Downturn	130mm
Width	70mm
Weight/ Gerard unit	2.5kg
Weight/Colortile unit	1.6kg

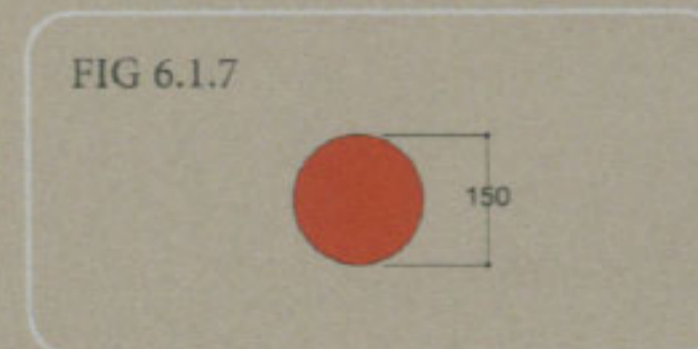

BARREL END 150	
Diameter	150mm
Weight/ Gerard unit	0.1kg
Weight/Colortile unit	0.1kg

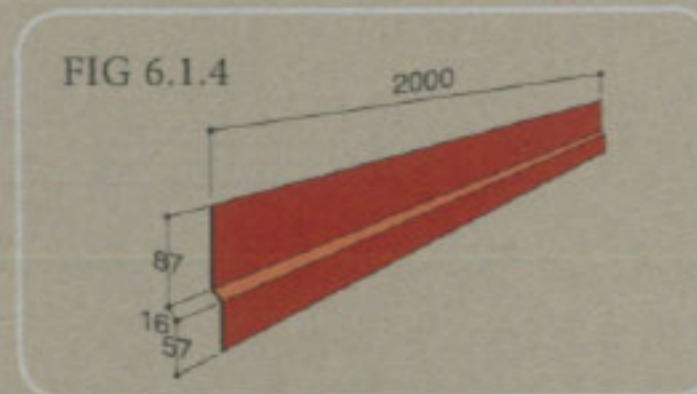

SIDE FLASHING	
Overall length	2000mm
Length of cover	1900mm
Upturn	86mm
Width	17mm
Downturn	57mm
Weight/ Gerard unit	1.4kg
Weight/Colortile unit	0.9kg

6.2 PACKAGING

Tiles are packed on wooden pallets of base dimensions 1400 x 1100mm. The maximum height of a pallet is 820mm for Gerard Textured Tiles and 500mm for Gerard Satin Tiles. 350 Gerard Textured Tiles are stacked on each pallet with a maximum weight of 1150kg. The maximum weight for a pallet of 500 Gerard Satin Roofing Tiles is 1100kg. If required, tiles can be packaged in built up timber crates of base dimensions 1500 x 1200mm and a maximum height of 1000mm. Up to 500 tiles are contained in each crate with a maximum weight of 1500kg.

6.3 STORAGE AND HANDLING

If stored outside, a waterproof cover must be placed over the tiles to keep them dry and prevent damage.

Care should be taken when handling the tiles to avoid damage to the surface. Where minor damage does occur, the Touch Up Kit should be used to repair the surface.

SPECIAL FLASHINGS

Quotations are available on request for special flashings, accessories and flat sheet coated products.

VISION TILES (CLEAR)

Formed from Acrylic sheet in dimensions as per standard tile.

TOUCH UP KIT

Touch Up Kits are available to repair surface damage if incurred during installation.



AHI ROOFING LIMITED

90 - 104 Felton Mathew Avenue
 Glen Innes, Auckland, New Zealand
 PO Box 18071
 Glen Innes, Auckland, New Zealand
 P: +64 (0)9 978 9010
 F: +64 (0)9 978 9069
 E: export@ahiroofing.co.nz



www.ahiroofing.com